

design & experience



 **VEZZOSI**

01

pag. 09

lavaggi
washings
lavages

48 COOPER art. 3280	14 INDUSTRIAL art. 3110
49 COOPER MASSAGE art. 3290	14 INDUSTRIAL MASSAGE art. 3120
49 COOPER RELAX art. 3285	14 INDUSTRIAL RELAX art. 3115
44 CURVE art. 9805	28 IRON art. 3038
45 CURVE MASSAGE art. 9807	29 IRON MASSAGE art. 3040
45 CURVE RELAX art. 9806	29 IRON RELAX art. 3039
60 DYLAN art. 3295	56 NAPOLEONE art. 3130
61 DYLAN MASSAGE art. 3305	56 NAPOLEONE III art. 3135
61 DYLAN RELAX art. 3300	42 NIRVANA art. 3250
62 EDDIE art. 8060/16	43 NIRVANA MASSAGE art. 3270
62 EDDIE MASSAGE art. 8069/16	43 NIRVANA RELAX art. 3260
62 EDDIE RELAX art. 8065/16	55 POD AIR MASSAGE art. 9003
63 EDDIE SOFÀ art. 8066	55 POD art. 9001
63 EDDIE SOFÀ MASSAGE art. 8068	55 POD RELAX art. 9004
63 EDDIE SOFÀ RELAX art. 8067	51 PUSH-UP MASSAGE art. 9360
24 FANCY art. 3045	50 PUSH-UP RELAX art. 3350
25 FANCY MASSAGE art. 3055	66 ROYAL WASH art. 8070
25 FANCY RELAX art. 3050	67 ROYAL WASH MASSAGE art. 8077
18 FLORA BEAUTY BASKET art. 3075	67 ROYAL WASH RELAX art. 8075
19 FLORA BEAUTY BASKET MASSAGE art. 3085	39 S-COLOR art. 9635
19 FLORA BEAUTY BASKET RELAX art. 3080	37 S-MASSAGE art. 9620
52 HOP art. 3335	38 S-MAXI art. 9640
53 HOP MASSAGE art. 3345	36 S-RELAX art. 9601
53 HOP RELAX art. 3340	33 URBAN MASSAGE art. 3856
	32 URBAN RELAX art. 3855

02

pag. 69

poltrone lavoro
rotating chairs
fauteuils tournants

115 ADAM art. 1322
103 APPLE art. 8136
94 CARNABY art. 1396
87 CURVE art. 9850/9851
86 CURVE art. 9855/9856
112 DANDY art. 8169
102 DEVIL art. 1327
95 DORA art. 1310
96 EPOQUE art. 9311
109 EVA art. 1321
72 FANCY art. 1410-P07/1410-P06
75 FANCY art. 1410-P04
80 FLORA art. 1415-P05
108 FRIDA art. 1320
89 FUNKY art. 9315
114 GINGERMAN art. 1326
71 INDUSTRIAL CHAIR art. 1306
83 IRON art. 1405/1406
84 LUPE art. 1300
90 MEG art. 8145
113 NEWTON PLUS art. 9314
107 OXFORD art. 1397
99 PICCADILLY art. 1398
76 POSH CHAIR art. 1307
79 POSH BLACK art. 1308
105 ROYAL art. 8125
93 S-CHAIR art. 9310
106 TRAFALGAR art. 8175
100 UMA art. 1350

03

pag. 117

posti lavoro
styling units
coiffeuses

185 BAROQUE art. 9325	205 LIBERTY art. 8268
165 BROOKLYN art. 4109	203 MAKE UP art. 4038
212 CLASH 1 art. 8233	201 MARILYN ISLAND art. 4030
213 CLASH art. 8230	206 MOVIE art. 8241/16
145 CLEOPATRA art. 4105	182 NATURAL DOUBLE art. 9324
146 CLEOPATRA WALL art. 4100	181 NATURAL LIGHT art. 9321
215 CURVE BARBIERE art. 9840	184 NATURAL+ art. 9326
161 DOS LIGHT art. 8236/16	162 NEW YORK art. 4015
171 EDEN + art. 8275P	160 ONE LIGHT art. 8234/16
170 EDEN art. 8275	194 PASSION GLASS art. 4008
152 EPOQUE 1 art. 9330	194 PASSION GLASS LIGHT art. 4007
150 EPOQUE WALL art. 9327	175 POLARIS art. 5180
135 FANCY CENTRALE art. 4113	177 POLARIS WALL art. 5182
132 FANCY DOPPIO art. 4110	176 POLARIS+ art. 5181
132 FANCY DOPPIO CON PIANO LAVORO art. 4110/M	129 POSH art. 4019
136 FANCY SINGOLO art. 4111	126 POSH DOUBLE art. 4018
174 FELIPE art. 4039	189 QUEEN art. 4009
193 FLAVIA art. 8242/16	189 QUEEN LIGHT art. 4009/B
139 FLORA DOPPIO art. 4114	190 QUEEN PLUS art. 4010
140 FLORA SINGOLO art. 4115	220 RETRÒ 2.0 art. 5052
178 GIOTTO art. 8246	221 RETRÒ art. 5051
179 GIOTTO+ art. 8247	173 S-WALL art. 5150
217 GOYA art. 8272	198 SOPHIA art. 4023
214 IKON art. 8245	199 SOPHIA ONE art. 4021
120 INDUSTRIAL ISLAND art. 4016	200 SOPHIA WALL art. 4022
123 INDUSTRIAL art. 4017	156 STRIPE art. 8217/16
166 IRON art. 4108/4108L	156 STRIPE LIGHT art. 8218/16
216 JAZZ art. 4191L/4191R	209 SUPERNOVA art. 8269
204 KOMODO art. 4165	210 WATCH art. 9328

04

pag. 223

tavoli cassa
cash register table
tables caisse

242 AMELIE art. 8426
241 AUDREY art. 8417
246 COLOUR DESK art. 6300
235 CORNER DESK art. 6756
245 DORIAN art. 8425
228 FANCY CASSA art. 6830
229 FLORA CASSA art. 6835
224 INDUSTRIAL DESK art. 6840
230 IRON CASSA art. 6825
247 J-LO DESK art. 8415
233 LOVE art. 6755
236 LUZ art. 6758
239 MARILYN DESK art. 6030
234 NATURAL DESK art. 6190
238 SMILE art. 8416
248 SPICE art. 8410
251 WELCOME art. 8428

05

pag. 253

poltrone attesa
waiting chairs
fauteuils attente

255 FLORA WAITING art. 2075
259 FUSION art. 5800
260 GINEVRA art. 2280/2281
261 GINEVRA SOFÀ art. 2282/2283
257 IL BACELLO art. 2950
257 IL RETTANGOLO art. 2900
256 LOLITA art. 2245
254 POSH WAITING art. 2070
257 QUADROTTO art. 2800
265 ROYAL SOFÀ art. 8325/8326
264 ROYAL WAITING art. 8320/8321
262 STAR art. 2130
263 STAR3 art. 2135

06

pag. 267

mobili expo
expo furnishing
meubles expo

273 EXPO NEW art. 8601/16
269 FLORA EXPO art. 9377
270 NATURAL EXPO art. 506
272 XILEMA EXPO art. 510

07

pag. 275

mobili servizio
salon furnishing
meubles de rangement

281 BEAUTY art. 9355
278 COLOUR SERVICE art. 6305
276 IRON EXPO art. 9376
282 LUXURY art. 9350
287 MOBILI art. 702
286 MOBILI art. 705
285 MOBILI art. 706
284 MOBILI art. 707
291 MOBILI art. 8725/16-8720/16 - 8700/16
288 MOBILI art. 8730/16
289 MOBILI art. 8731/16
290 MOBILI art. 8726
279 WOOD art. 9360/B - 9360

08

pag. 293

complementi
complements
compléments

- 303 BOLERO
art. 7143
- 299 BRAD
art. 8251/16
- 299 COOL
art. 4215
- 302 CURVE PORTAPHON
art. 9890
- 294 FANCY TAVOLINO
art. 4203
- 295 FLORA TAVOLINO
art. 4204
- 304 FRIEND
art. 7290
- 297 GRAFFIO
art. 7190
- 304 HOLLYWOOD
art. 7291
- 303 KID
art. 8252
- 300 METEOR BASIC
art. 5075
- 300 METEOR+
art. 4190P
- 301 OZZY
art. 7272
- 296 POSH CLOSET
art. 7196
- 302 SENSOR
art. 7275
- 298 SOUL
art. 4225
- 298 STYLE
art. 8250
- 305 TENDER
art. 7293
- 305 TENDER DOUBLE
art. 7292
- 302 VORTICE
art. 7250
- 301 WOW
art. 7270
- 297 XILEMA CLOSET
art. 7195
- 298 YORK
art. 4201
- 301 YOUNG
art. 7271

09

pag. 307

estetica
beauty items
esthétique

- 310 EXPO NAILS
art. 10106/N
- 311 GRACE DOUBLE
art. 10064/N
- 311 GRACE+
art. 10065/N16
- 310 MARILYN NAILS
art. 10105/N
- 308 POPPER
art. 10015/N

10

pag. 313

poggiapiedi - piedi
foot-rest and feet
repose-pieds - pieds

- 316 PIEDI
art. P05
- 316 PIEDI
art. P06/P07
- 316 PIEDI
art. P15
- 316 PIEDI
art. P20/P21
- 317 PIEDI
art. P30/P31
- 317 PIEDI
art. P51
- 317 PIEDI
art. P70
- 316 PIEDI
art. P80/P81
- 317 PIEDI
art. P90/P95
- 317 PIEDI
art. P98/P99
- 314 POGGIAPIEDI
art. 7310
- 314 POGGIAPIEDI
art. 7310
- 314 POGGIAPIEDI
art. 7330/V
- 314 POGGIAPIEDI
art. 7340

11

pag. 319

caschi
hairdryer
sechoir

- 321 DARWIN
art. 1000/1010/1120
- 320 GINKO
art. 1100/1120/1100
- 323 LUCÉ
art. 1800/1810/1820
- 322 VICTOR
art. 1610/1620

12

pag. 325

schemi idraulici
hydraulic plans
schémas hydrauliques

- 331 COOPER
art. 3080/ 3085/ 3090
- 330 CURVE
art. 9805/9806/9807
- 334 DYLAN
art. 3295/ 3300/ 3305
- 336 EDDIE
art. 8060/ 8065/ 8069
- 337 EDDIE SOFÁ
art. 8066/ 8067/ 8068
- 327 FANCY
art. 3045/3050/3055
- 326 FLORA BEAUTY BASKET
art. 3075/3080/3085
- 332 HOP
art. 3335/ 3340/ 3345
- 326 INDUSTRIAL
art. 3110/3115/3120
- 327 IRON
art. 3038/3039/3040
- 333 NAPOLEONE
art. 3130
- 333 NAPOLEONE III
art. 3135
- 329 NIRVANA
art. 3250/ 3260/ 3270
- 333 POD
art. 9001/ 9003/9004
- 332 PUSH UP
art. 3350/ 3360
- 335 ROYAL WASH
art. 8070/ 8075/ 8077
- 328 S-COLOR
art. 9635
- 328 S-MASSAGE
art. 9620
- 328 S-MAXI
art. 9640
- 328 S-RELAX
art. 9601
- 328 URBAN
art. 3855/ 3856

13

pag. 339

colori e materiali
colours and materials
coloris et matériaux

- TAPPEZZERIA
UPHOLSTERY
TAPISSERIE
- 340 NORMAL SKAI
- 340 SPECIAL SKAI
- 341 TOP SKAI
- 342 LAMINATI
PLASTIC LAMINATED
STRATIFIÉS
- 343 NOBILITATO
PRE-LAMINATED
LAMINÉ

design & experience

 **VEZZOSI**

Da oltre 40 anni la realtà italiana **Vezzosi srl** mette tutta la passione per il design e l'amore per la bellezza al servizio di **parrucchieri e barber**, occupandosi della **progettazione** e della **produzione di complementi d'arredo di design**.
I nostri clienti si rivolgono a noi fiduciosi e sicuri di **ritrovare qualità, servizio, innovazione e creatività in ogni opera d'arte che creiamo**.
Queste sono le linee guida che da sempre seguiamo e che ci permettono di essere azienda leader sul mercato e attiva **anche oltre i confini nazionali**.

Vezzosi: design furnishings for hairdressing salons and barbers

For over 40 years, the Italian company **Vezzosi srl** has put all of its passion for the design and love of beauty at the service of **hairdressing salons and barbers**, overseeing the **design and production of design furnishing complements**.
Our customers return to us, confident and safe in the knowledge of being able to **find quality, service, innovation and creativity in every work of art that we create**.
These are the guidelines that we have always followed and that make us a leading company in the market and **also active globally**.

Vezzosi: le mobilier design pour salons coiffeurs et barbiers

Depuis plus de 40 ans, l'entreprise italienne **Vezzosi srl** met toute sa passion pour le design et son amour de la beauté au service des **coiffeurs et des barbiers**, en s'occupant de la **conception** et de la **production de compléments d'ameublement design**.
Nos clients viennent à nous confiants, certains de **retrouver la qualité, le service, l'innovation et la créativité dans chaque œuvre d'art que nous créons**.
Ce sont les lignes directrices que nous avons toujours suivies et qui nous permettent d'être une entreprise leader sur le marché et active **même au-delà des frontières nationales**.

Vezzosi: arredi di design per parrucchieri e barber

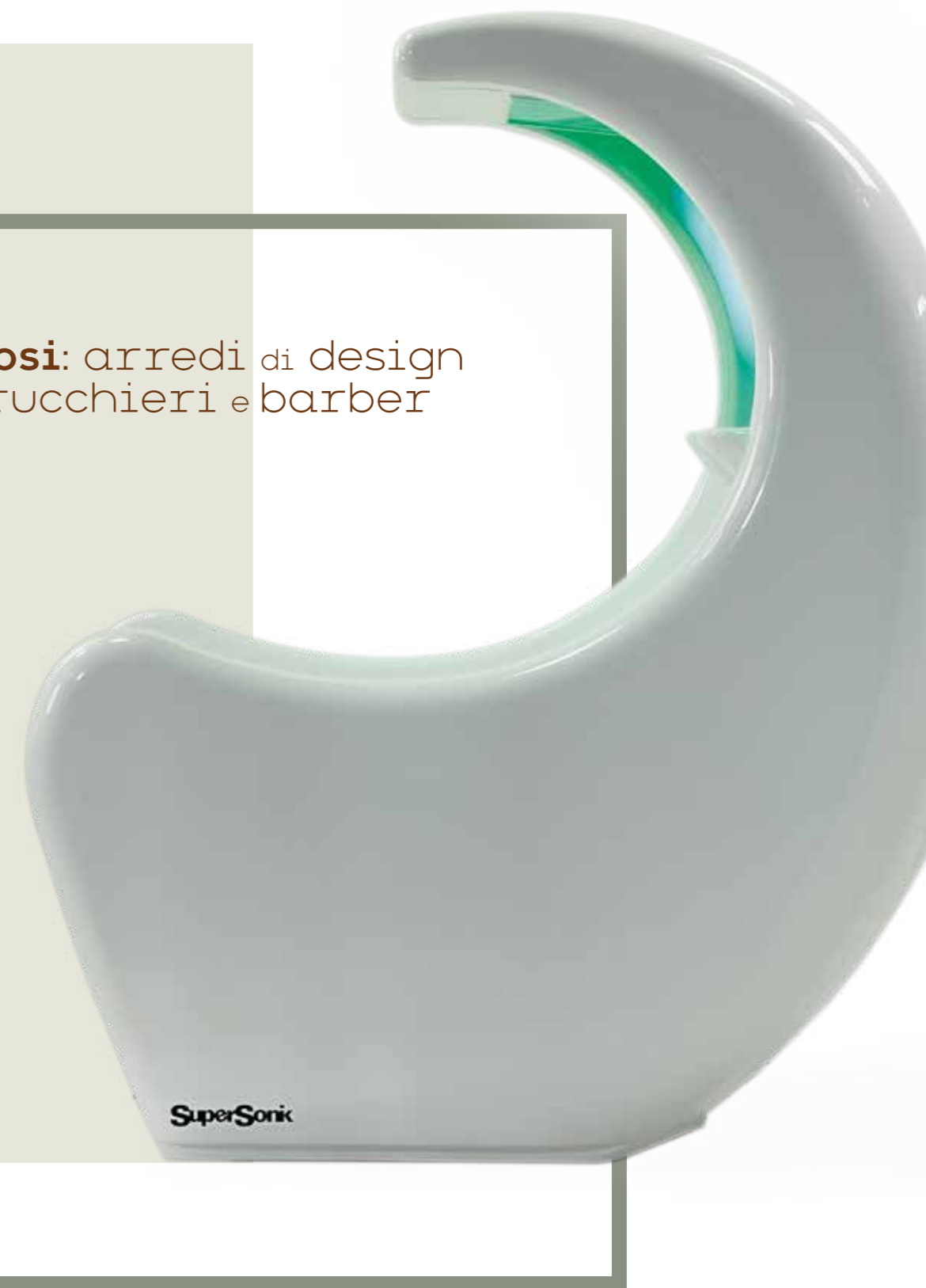

VEZZOSI

qualità e creatività
made in italy



L'attenzione meticolosa alla qualità, la scelta accurata dei materiali, il gusto per la sperimentazione delle linee, le collaborazioni con designer di fama internazionale, uno sguardo sempre rivolto alla praticità dei prodotti e alla loro versatilità: l'esperienza si acquisisce col tempo, la professionalità si apprende con la passione, il successo si costruisce giorno dopo giorno.

Vezzosi questo lo sa e grazie al suo percorso può dimostrarlo. Linee essenziali, dettagli ricercati, un design che cattura la semplicità della bellezza, una perfetta fusione tra l'esperienza nella tecnica e le esigenze contemporanee. Il **prestigio della tradizione creativa italiana** al servizio di **Vezzosi** per riscoprire l'essenzialità della bellezza, definire uno stile, identificarsi con un forte segno di riconoscimento. Per lasciare un'impronta che colpisce ed emoziona. I materiali trendy e resistenti, selezionati e inalterabili rispondono alla necessità di dare il massimo della pregevolezza e al contempo valorizzare le strutture dal design contemporaneo scelte da **Vezzosi** per creare un nuovo concetto di salone funzionale e all'avanguardia.

Vezzosi mira a valorizzare la propria produzione **Made in Italy** per aiutare il consumatore a comprendere l'importanza del binomio "qualità e creatività".



quality and creativity made in italy

Attention to the quality, accurate choice of materials, taste for the experiment, collaboration with important designers, versatility of the articles: **Vezzosi** is experience, professionalism and success. Essential lines, refined details, this design captures the simplicity of the beauty as a perfect fusion between experience and contemporaneity. The **italian tradition** becomes emotion with **Vezzosi**.

Vezzosi uses trendy and resistant materials to emphasize the contemporary design and to create a new functional and modern salon.

Vezzosi aims to emphasize its own production totally **Made in Italy** in order to help the customer understand the importance of the binomial: "quality and creativity".

qualità et creatività made in italy

L'attention à la qualité, le choix soigneux des matériaux, le goût pour la sperimentation, la collaboration avec designers connus dans le monde entier: cette expérience et ce caractère professionnel font partie du succès que **Vezzosi** construit jour par jour. Lignes essentielles, détails recherchés, un design qui capture la simplicité de la beauté, une fusion parfaite entre les exigences techniques et les tendances modernes.

Le **prestige du design italien** au service de **Vezzosi** pour laisser une empreinte qui touche et émotionne. Les matériaux utilisés répondent à la nécessité de garantir la fiabilité et au même temps valoriser le nouveau concept de salon fonctionnel et à l'avant-garde.

Vezzosi vise à valoriser sa propre production **Made in Italy** pour aider le client à comprendre l'importance du binôme "qualité et créativité".

la progettazione di un negozio per parrucchiere passa da **Vezzosi**

La realtà italiana Vezzosi offre un servizio di progettazione tridimensionale che grazie alle più attuali innovazioni informatiche ti permette di ammirare in anteprima il salone che fino ad ora potevi vedere solo nella tua immaginazione. Tutto ha inizio dall'ascolto delle richieste e necessità del cliente, il quale viene seguito passo dopo passo in tutti gli step fondamentali per la corretta realizzazione di un negozio per parrucchiere o di un centro estetico degni di nota. Il nostro team di architetti provvede a identificare i tratti caratteristici e crea una piantina in 2D, la quale servirà per la successiva lavorazione in 3D.

La progettazione a computer si è rivelata la tecnica migliore per dare il giusto valore a quelli che sono i prodotti di design che creiamo. Ma il tratto per noi più importante è la possibilità di permettere al committente di avere subito chiaro quale sarà il risultato finale. Il photo rendering consente di ottenere una copia fedele del salone in tutti i suoi dettagli, grazie all'utilizzo di colori e finiture particolarmente realistici. Non ci limitiamo solamente a fornire una visuale dall'alto, ma siamo in grado di produrre soluzioni visive realizzate su angolazioni differenti.

Lo scopo di tutto il processo digitale è la trasparenza di tutti i passaggi, dal primo sopralluogo, passando per l'installazione degli articoli scelti, fino alla consegna finale. Potrai vedere lo spazio dall'interno, come se venissi proiettato in tempo reale sul posto, così da analizzare le singole postazioni, l'armonia di tutti gli elementi e la disposizione dell'arredamento.

Per noi, questo si traduce in un servizio di customer care completo e per te in un risparmio notevole di tempo. Potrai dedicarti ad altre questioni importanti e lasciare a noi il compito di realizzare i tuoi desideri.

VEZZOSI

the design of a hairdresser's shop passes through **Vezzosi**

The Italian company Vezzosi offers a service of three-dimensional design that, thanks to the most current computer innovations, is used to preview the salon that until now you could only see in your imagination.

It all starts with listening to the customer's requirements and needs, which is followed step-by-step through all the fundamental stages for the correct creation of a hairdressing shop or of an impressive beauty centre. Our team of architects identifies the characteristic features and creates a 2D map, which will be used for the subsequent 3D processing.

Computer design has proved to be the best technique for giving the right value to the design products we create.

But the most important trait for us is the possibility of allowing the client to have an immediate clear picture of what the final result will be. Photo rendering is used to obtain a faithful copy of the salon in all its details, thanks to the use of particularly realistic colours and finishes.

We don't just provide a top view but we are able to produce visual solutions created at different angles. The purpose of the entire digital process is the transparency of all the steps, the first inspection, installation of the selected items and the final delivery. You will be able to see the space from the inside, as if you were projected in real time on the spot, in order to be able to analyse the individual stations, the harmony of all the elements and the arrangement of the furniture. For us, this translates into a complete customer care service and for you into significant time savings. You can dedicate yourself to other important issues and leave it to us to make your wishes come true.



la conception d'un salon de coiffure passe par **Vezzosi**

La réalité italienne Vezzosi offre un service de conception tridimensionnelle qui, grâce aux dernières innovations informatiques, vous permet d'admirer en avant-première le salon que vous ne pouviez jusqu'à présent voir que dans votre imagination.

Tout commence par l'écoute des demandes et des exigences du client, qui est suivi pas à pas dans toutes les étapes essentielles à la bonne réalisation d'un salon de coiffure ou d'un institut de beauté digne de ce nom.

Notre équipe d'architectes identifiera les éléments caractéristiques et créera un plan 2D, qui sera utilisé pour le traitement 3D ultérieur.

La conception assistée par ordinateur s'est avérée être la meilleure technique pour donner la juste valeur aux produits design que nous créons.

Mais la caractéristique la plus importante pour nous est la possibilité de permettre au client de connaître immédiatement le résultat final.

Le rendu photo permet d'obtenir une copie fidèle du salon dans tous ses détails, grâce à l'utilisation de couleurs et de finitions particulièrement réalistes. Nous ne nous contentons pas de fournir une vue d'ensemble, nous sommes en mesure de produire des solutions visuelles sous différents angles.

L'objectif de l'ensemble du processus numérique est la transparence de toutes les étapes, de la première inspection à la livraison finale, en passant par l'installation des articles choisis. Vous pourrez voir l'espace de l'intérieur, comme si vous étiez projeté en temps réel sur place, afin d'analyser les différents postes, l'harmonie de tous les éléments et la disposition du mobilier.

Pour nous, cela se traduit par un service complet d'assistance à la clientèle et pour vous, par un gain de temps considérable. Vous pouvez vous concentrer sur d'autres questions importantes et nous laisser le soin de réaliser vos souhaits.



01

lavaggi
washings
lavages

 **VEZZOSI**

washing unit with
massage by air flux:
the ultimate comfort

Relaxing and surrendering completely to your thoughts are times that each of us is entitled to from time to time.

But why not also do it when you are at the hairdresser's and increase the feeling of well-being and comfort?

The Italian company **Vezzosi** deals with the **design** and **creation** of **stations for washing unit with massage**, custom-made and covered with **skai upholstery**. All our work revolves around the constant search for an optimal level of relaxation to **help beauty professionals** offer a professional and complete service.

Being pampered by the expert hands of your trusted hairdresser is priceless and doing so while comfortably seated in a **latest technology massage chair** is the best you could wish for.

bac de lavage avec
massage par flux d'air:
la cinquième essence du confort

Se détendre et s'abandonner complètement à nos pensées sont des moments que chacun d'entre nous mérite de s'accorder de temps en temps. Mais **pourquoi ne pas le faire également lorsque vous êtes chez le coiffeur** et amplifier la sensation de bien-être et de confort?

La société italienne **Vezzosi** s'occupe de la **conception** et de la **réalisation de postes de lavage avec massage**, réalisés sur mesure et **revêtus de skai**. Tout notre travail tourne autour de la recherche constante d'un niveau de relaxation optimal pour **aider les professionnels du secteur beauty** à offrir un service professionnel et complet.

Se laisser choyer par les mains expertes de votre coiffeur de confiance n'a pas de prix, surtout si l'on est confortablement assis sur un **fauteuil de massage de dernière technologie**.

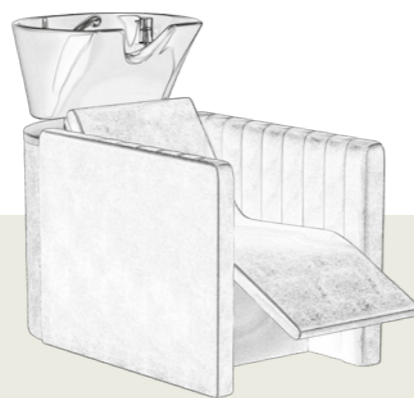
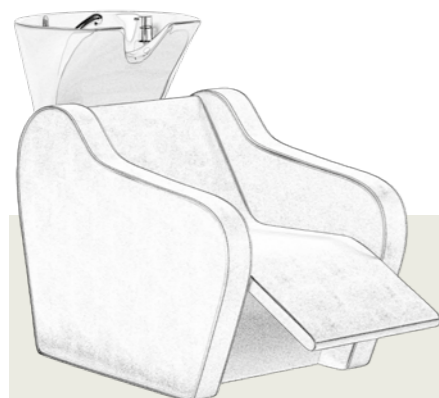

Il nostro sistema di massaggio linfodrenante a flusso d'aria a variazione continua garantisce al cliente un'esperienza di benessere e relax totale grazie alla qualità dei componenti totalmente **made in Italy** e ad un'evoluta ingegnerizzazione che permette uno standard qualitativo e di durata al top nel settore.

Our full lymph-draining and invigorating massage by air flux system guarantees the customer an experience of total well-being and relaxation thanks to the quality of the components totally **made in Italy** and to an advanced engineering that allows a standard of quality and duration at the top in the field.

Notre système de massage de drainage lymphatique à flux d'air variable en continu garantit au client une expérience de bien-être total et de relaxation grâce à la qualité des composants totalement **fabriqués en Italie** et à une ingénierie avancée qui permet un standard de qualité et de durée au sommet dans le secteur.

La produzione diretta e l'assemblaggio all'interno del nostro laboratorio del compressore d'aria ci permette di garantire al sistema **5.000 ore di vita** equivalenti a **30.000 cicli di massaggio**. L'elettronica sviluppata in collaborazione con un team di ingegneri consente di controllare il numero di massaggi effettuati e di verificare eventuali anomalie attraverso codici di allarme che appaiono sul display della tastiera.

The direct production and assembly of the air compressor within our laboratory allows us to guarantee the system **5,000 hours of life** equivalent to **30,000 massage cycles**. The electronics developed in collaboration with a team of engineers allows you to check the number of massages performed and to check for any anomalies through alarm codes that appear on the keyboard display.

La production et l'assemblage **directs** du compresseur d'air dans notre laboratoire nous permettent de garantir au système **5.000 heures de vie** équivalentes à **30.000 cycles de massage**. L'électronique développée en collaboration avec une équipe d'ingénieurs vous permet de vérifier le nombre de massages effectués et de vérifier d'éventuelles anomalies grâce à des codes d'alarme qui s'affichent sur l'écran du clavier.

I nostri lavatesta con massaggio prima della spedizione e consegna sono sottoposti ad un processo di **autocollauda di 2 ore** nei quali vengono testate tutte le funzioni di massaggio, intensità e movimentazioni.

Our shampoo units with massage, before shipment and delivery, are subjected to a **2-hour self-testing process** in which all the massage functions, intensity and movements are tested.

Avant expédition et livraison, nos shampoings avec massage sont soumis à un **processus d'auto-test de 2 heures au cours** duquel toutes les fonctions, intensités et mouvements de massage sont testés.

L'alta qualità dei componenti utilizzati come gli evoluti motori brushless nel compressore e la sofisticata tecnologia della centralina elettronica ci permette di offrire al cliente, su richiesta, un'estensione di **garanzia** sui suddetti componenti fino a **5 anni** dalla data di acquisto*.

The high quality of the components used such as the advanced brushless motors in the compressor and the sophisticated technology of the electronic control unit allows us to offer the customer, upon request, an **extended warranty** on the aforementioned components up to **5 years** from the date of purchase*.

La haute qualité des composants utilisés tels que les moteurs brushless avancés du compresseur et la technologie sophistiquée de l'unité de commande électronique nous permettent d'offrir au client, sur demande, une **garantie prolongée** sur les composants susmentionnés jusqu'à **5 ans** à compter de la date d'achat*.

- * per l'estensione di garanzia consultare il listino prezzi.
- * for the warranty extension, see the price list.
- * pour l'extension de garantie, voir la liste des prix.

lavaggio con massaggio
a flusso d'aria:
la quinta essenza del comfort



Rilassarsi e abbandonarsi completamente ai propri pensieri sono momenti che ognuno di noi merita di ritagliarsi di tanto in tanto. **Ma perché non farlo anche mentre si è dal parrucchiere** e amplificare la sensazione di benessere e comfort? L'azienda italiana **Vezzosi** si occupa della **progettazione** e della **realizzazione di postazioni per il lavaggio con massaggio**, su misura e rivestite con **tappezzeria in skai**. Tutto il nostro lavoro ruota attorno alla costante ricerca di un ottimale livello di relax per **aiutare i professionisti del settore beauty** a offrire un servizio professionale e completo. Lasciarsi coccolare dalle sapienti mani del proprio parrucchiere di fiducia non ha prezzo e farlo comodamente seduti su **una poltrona massaggiante di ultima tecnologia** è il massimo che si possa desiderare.





industrial

industrial - ART. 3110 - relax - ART. 3115 - massage - ART. 3120 



ART. 3110 - Struttura in tubolare verniciato nero opaco. Tappezzeria in skai. Lavello basculante.
 Tubular structure matt black painted. Upholstery in skai. Tilting basin.
 Structure tubulaire verni noir matt rembourrage en skai, cuvette basculante.

ART. 3115 - Struttura in tubolare verniciato nero opaco. Tappezzeria in skai. Lavello basculante. Poggiagambe regolabile elettricamente con tastiera one touch.
 Tubular structure matt black painted. Upholstery in skai. Tilting basin. Adjusting leg rest by electronics keyboard one touch.
 Structure tubulaire verni noir matt rembourrage en skai, cuvette basculante. Appui-jambes réglable par l'électronique avec clavier one-touch.

ART. 3120 - Struttura in tubolare verniciato nero opaco. Tappezzeria in skai. Lavello basculante. Poggiagambe regolabile elettricamente per servizio relax. Massaggio totale linfodrenante a flusso ad aria a variazione continua.
 Tubular structure matt black painted. Upholstery in skai. Tilting basin adjusting legrest by electronics, massage total lympho-drainant et tonifiant par flux d'air a variation continue.

Structure tubulaire verni noir matt rembourrage en skai, cuvette basculante. Appui-jambes réglable par l'électronique, massage total lympho-drainant et tonifiant par flux d'air a variation continue.

ART. 3110

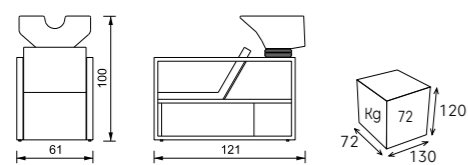

ART. 3115 - 3120

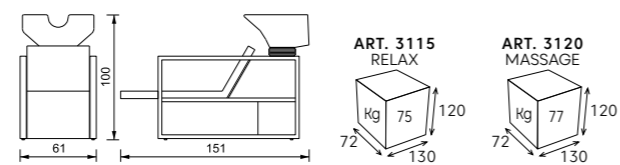

industrial

the
**Beauty
Basket**



flora beauty basket - ART. 3075



ART. 3075 - Struttura imbottita in skai, lavabo basculante, sotto lavello e scocca posteriore in materiale plastico.
 Upholstered structure in skai, tilting washbasin, under sink and rear shell in plastic material.
 Structure tapissée en skai, vasque basculante, sous évier et coque arrière en matière plastique.

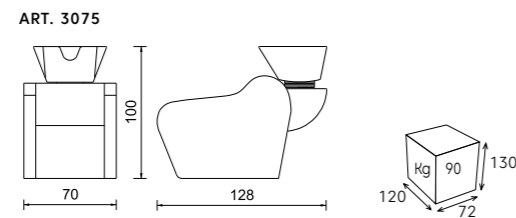

flora beauty basket relax - ART. 3080 - massage - ART. 3085 



ART. 3080 - 3085 - Struttura imbottita rivestita in skai, lavabo basculante, sotto lavello e scocca posteriore in materiale plastico, poggiatesta regolabile elettronicamente. Massaggio totale linfodrenante a flusso d'aria, a variazione continua, su tutto il corpo.
 Upholstered structure covered in skai, tilting washbasin, under-sink and rear shell in plastic material, electronically adjustable legrest.
 Total lymphatic drainage massage with air flow, continuously variable, on the whole body.
 Structure rembourrée recouverte de skai, vasque basculante, sous-évier et coque arrière en matière plastique, repose-jambes réglable électroniquement. Massage de drainage lymphatique total avec flux d'air, variable en continu, sur tout le corps.

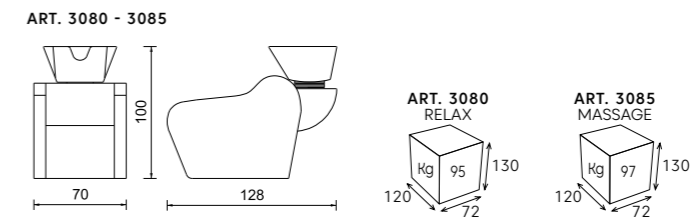

flora beauty basket modulare - relax modulare - massage modulare



Struttura imbottita rivestita in skai, lavabo basculante, sotto lavello e scocca posteriore in materiale plastico, fianchi alti con struttura imbottita rivestita in skai e aperture in vetro stratificato trasparente, calotta superiore basculante composta da una parte anteriore in plexiglass bianco, con retroilluminazione a led per migliorare la visibilità all'interno della vasca, e da una parte posteriore in plexiglass trasparente con funzione parafuoco. Parte superiore della calotta rivestita in skai.
 Relax e Massage: poggiatesta regolabile elettronicamente. Massaggio totale linfodrenante a flusso d'aria, a variazione continua, su tutto il corpo.
 Padded structure covered in skai, tilting washbasin, under sink and rear shell in plastic material, high sides with padded structure covered in skai and openings in transparent laminated glass, tilting upper cap composed of a front in white plexiglass, with LED backlighting to improve visibility inside the tank, and a rear part in transparent plexiglass with a breath cover function. Upper part of the shell covered in skai.
 Relax and Massage: electronically adjustable leg rest. Total lymphatic drainage massage with air flow, continuously variable, on the whole body.
 Structure rembourrée recouverte de skai, vasque basculante, sous évier et coque arrière en matière plastique, côtés hauts avec structure rembourrée recouverte de skai et ouvertures en verre feuilleté transparent, capot supérieur inclinable composé d'une façade en plexiglass blanc, avec led rétro-éclairage pour améliorer la visibilité à l'intérieur du réservoir, et une partie arrière en plexiglass transparent avec fonction parafuoco. Partie supérieure de la coquille recouverte de skai.
 Relax et Massage: repose-jambes réglable électroniquement.
 Massage de drainage lymphatique total avec flux d'air, variable en continu, sur tout le corps.

flora beauty basket modulare:
FIANCO - SIDE - CÔTÉ SX BEAUTY BASKET FLORA - ART. 3070SX
CALOTTA - CAP - CAPOT BEAUTY BASKET FLORA - ART. 3065
FIANCO CENTRALE - CENTRAL SIDE - CÔTÉ CENTRAL BEAUTY BASKET FLORA - ART. 3070C
FIANCO - SIDE - CÔTÉ DX BEAUTY BASKET FLORA - ART. 3070DX

flora beauty basket modulare



A FIANCO - SIDE - CÔTÉ SX BEAUTY BASKET FLORA — ART. 3070SX **C** FIANCO CENTRALE - CENTRAL SIDE - CÔTÉ CENTRAL BEAUTY BASKET FLORA — ART. 3070C
B CALOTTA - CAP - CAPOT BEAUTY BASKET FLORA — ART. 3065 **D** FIANCO - SIDE - CÔTÉ DX BEAUTY BASKET FLORA — ART. 3070DX

Possibilità di replicare in batteria i lavaggi con soluzione di continuità. Fianchi alti con strutture imbottite rivestite in skai e aperture in vetro stratificato trasparente, calotte superiori basculanti composte da una parte anteriore in plexiglass bianco, con retroilluminazione a led per migliorare la visibilità all'interno della vasca, e da una parte posteriore in plexiglass trasparente con funzione parafuoco. Parte superiore della calotta rivestita in skai.

Possibility to replicate the washes in battery with continuity solution. High sides with padded structures covered in skai and openings in transparent laminated glass, tilting upper caps composed of a front in white plexiglass, with LED backlighting to improve visibility inside the tank, and from a rear part in transparent plexiglass with protection function. Upper part of the shell covered in skai.

Possibilité de reproduire les lavages en batterie avec une solution de continuité. Côtés hauts avec structures rembourrées recouvertes de skai et ouvertures en verre feuilleté transparent, capots supérieurs inclinables composés d'une façade en plexiglass blanc, avec rétroéclairage LED pour améliorer la visibilité à l'intérieur du réservoir, et d'une partie arrière en plexiglass transparent avec fonction de protection. Partie supérieure de la coquille recouverte de skai.

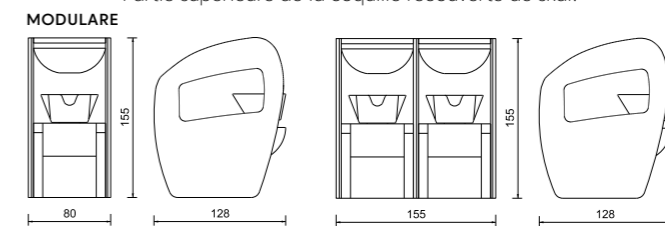



fancy - ART. 3045



ART. 3045 - Struttura imbottita rivestita in skai, lavabo basculante.
 Upholstered structure covered in skai, tilting washbasin.
 Structure tapissée recouverte de skai, vasque basculante.

ART. 3045

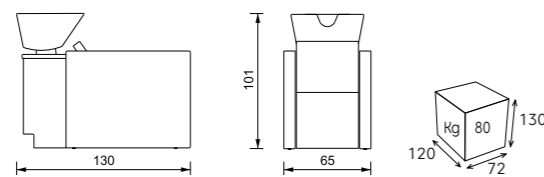

fancy relax - ART. 3050 - massage - ART. 3055 



ART. 3050 - 3055 - Struttura imbottita rivestita in skai, lavabo basculante, poggiatesta regolabile elettronicamente.
 Massaggio totale linfodrenante a flusso d'aria, a variazione continua, su tutto il corpo.
 Padded structure covered in skai, tilting washbasin, electronically adjustable legrest.
 Total lymphatic drainage massage with air flow, continuously variable, on the whole body.
 Structure recouverte de skai, vasque basculante, repose-jambes réglable électroniquement.
 Massage de drainage lymphatique total avec flux d'air, variable en continu, sur tout le corps.

ART. 3050 - 3055

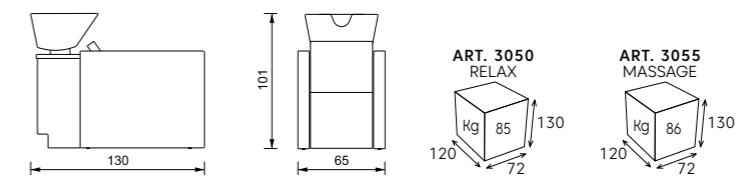



iron - ART. 3038



Metallo grezzo.
Raw metal.
Metal brut.

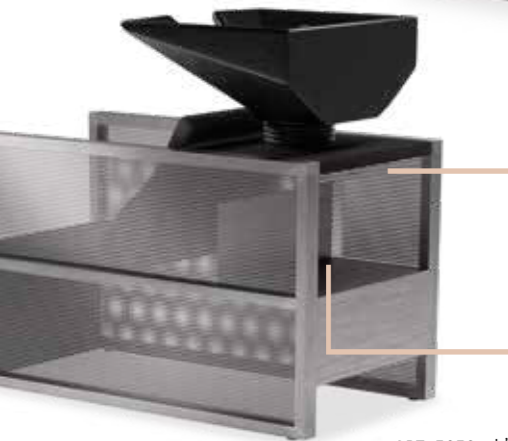

Porta prodotti posteriore.
Products holder in the backside.
Porte produits posterieur.

ART. 3038 - L'opacità del lavandino in colore nero e il comfort della seduta si combinano con lo stile urban effetto grezzo del reticolo metallico che definisce il perimetro della struttura. Il lavaggio basic Iron è perfetto per comunicare un mood industriale all'interno del salone per parrucchiere.

The opacity of the sink in black and the comfort of the seat combine with the urban raw effect style of the metal lattice that defines the perimeter of the structure.

The basic Iron wash is perfect for communicating an industrial mood within the hair salon.

L'opacità de l'évier en noir et le confort de l'assise se combinent au style urbain à effet brut du treillis métallique qui définit le périmètre de la structure. Le lavabo en fer basique est parfait pour communiquer une ambiance industrielle dans un salon de coiffure.

ART. 3038

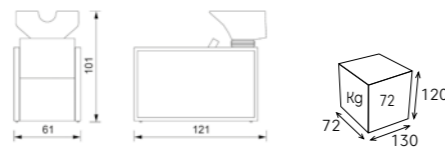

iron relax - ART. 3039 - massage - ART. 3040



Metallo grezzo.
Raw metal.
Metal brut.

ART. 3039 - La poltrona relax per la postazione lavaggio della collezione Iron offre tutta la comodità di una seduta regolabile con testiera e pratico poggiatesta. The relax armchair for the washing station of the Iron collection offers all the comfort of an adjustable seat with headboard and practical leg rest. Le fauteuil relax pour la station de lavage de la collection Iron offre tout le confort d'un siège réglable avec un appui-tête et un repose-jambes pratique.

ART. 3040 - Lo schienale e la seduta sono corredati di un innovativo sistema massaggiante total body. L'effetto metallico e grezzo della maglia completa perfettamente un salone dallo stile moderno e industriale.

The backrest and seat are equipped with an innovative total body massage system. The metallic and raw effect of the mesh perfectly complements a salon with a modern and industrial style.

Le dossier et l'assise sont équipés d'un système innovant de massage total du corps. L'effet métallique et rugueux de la maille complète parfaitement un salon au style moderne et industriel.

ART. 3039 - 3040

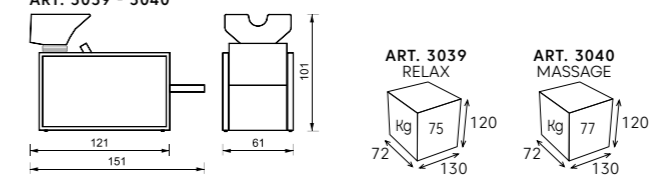



urban relax - ART. 3855



ART. 3855 - Lavello a doppia regolazione basculante e scorrevole, servizio total relax regolabile elettricamente, sottolavello in materiale poliuretano bianco con portabottiglie incorporato, tappezzeria in skai.

Wash unit with electronic leg rest and with double movement of the basin (tilting and sliding), frame in polyurethane material with shampoo holders, upholstery in skai.

Cuvette avec double réglage basculante et coulissante. Service de total relax réglable par l'électronique. Top postérieur en matériel poliurethane blanc avec porte shampoings. Tapisserie en skai.

ART. 3855

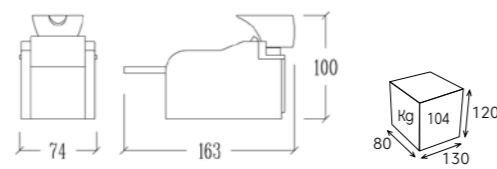

urban massage - ART. 3856



optional one touch

Alzagambe ad impulso automatico.

Automatic impulse leg lifters.

Leviers de jambes à impulsion automatique.



ART. 3856 - Massaggio totale linfodrenante a flusso d'aria a variazione continua su tutto il corpo.

Full lymph-draining and invigorating massage by air flux over the whole body.

Massage total lympho-drainant par flux d'air à variation continue sur tout le corps.

ART. 3856

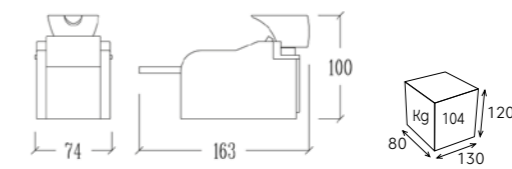



s-relax - ART. 9601



ART. 9601 - Struttura in vetroresina, doppio movimento del lavabo, basculante e scorrevole, poltrona regolabile elettricamente, fino alla posizione relax.

Structure in fiberglass, double movement of the basin, tilting and sliding, adjusting seat by electronic up to the relax position.

Structure en fibre de verre, double mouvement de la cuvette, basculante et coulissante, fauteuil réglable jusqu'à la position de relax.

ART. 9601

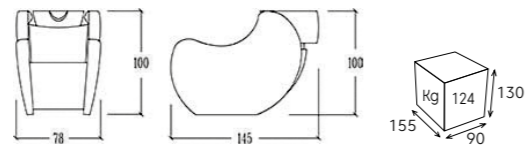

s-massage - ART. 9620 AIR MASSAGE



ART. 9620 - Massaggio totale linfodrenante a flusso d'aria a variazione continua su tutto il corpo.

Full lymph-draining and invigorating massage by air flux over the whole body.

Massage total lympho-drainant par flux d'air à variation continue sur tout le corps.

ART. 9620

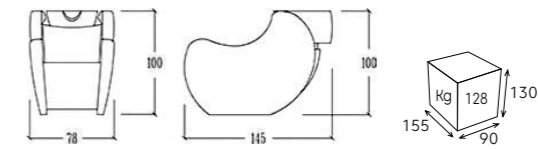

s-maxi - ART. 9640 AIR MASSAGE



ART. 9640 - Massaggio totale linfodrenante a flusso d'aria a variazione continua su tutto il corpo, display 15" per riproduzione immagini e filmati, porta usb (chiavetta inclusa), casse audio, vano porta shampoo, tappezzeria.

Full lymph-draining and invigorating massage by air flux over the whole body, audio speakers, shampoo holder, display 15" to launch images and videos, upholstery.

Fauteuil réglable jusqu'à la position de relax, massage total lymph drainant par flux d'air à variation continue sur tout le corps, display 15" pour reproduction images et video, tapisserie.

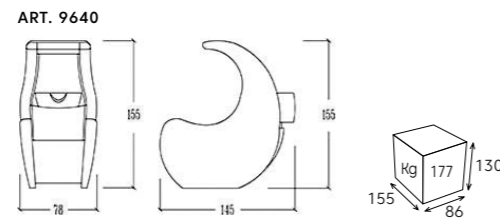

s-color - ART. 9635 AIR MASSAGE



ART. 9635 - Massaggio totale linfodrenante a flusso d'aria a variazione continua su tutto il corpo. Jack audio per lettore mp3 o smartphone, casse audio, vano porta shampoo, trasmissione di colori emozionali.

Full lymph-draining and invigorating massage by air flux over the whole body. Audio jack for mp3 players and smartphones, speakers, shampoo holders. transmission of relaxing colours integrated.

Massage total lymph drainant par flux d'air à variation continue sur tout le corps. Jack audio pour les lecteurs mp3 et smartphones, porte shampoo, transmission de couleurs émotionnels intégrés.

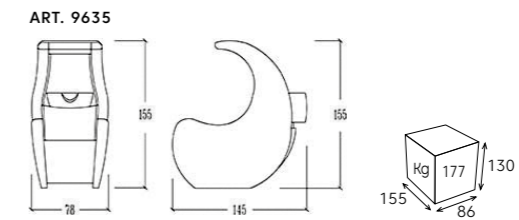



nirvana - ART. 3250



ART. 3250 - Lavello basculante, sotto lavello in materiale poliuretano con portashampoo incorporato, tappezzeria in skai.

Wash unit with tilting basin, frame in polyurethane material with shampoo holders, upholstery in skai.

Cuvette basculante, top posterieur en materiel poliurethane blanc avec porte shampoings incorporée. Tapisserie en skai.



ART. 3250

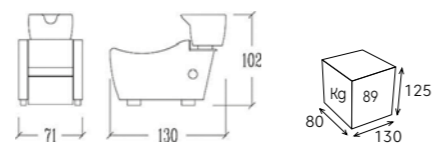

nirvana relax - ART. 3260 - massage - ART. 3270



optional
one touch
Alzagambe ad impulso automatico.

Automatic impulse leg lifters.

Leviers de jambes à impulsion automatique.



ART. 3260 - Poggiagambe regolabile elettricamente, tappezzeria in skai.

Adjusting leg-rest by electronics, upholstery in skai.

Appui-jambes réglable par l'électronique, tapisserie en skai.

ART. 3270 - Massaggio totale linfodrenante a flusso d'aria a variazione continua nella seduta e nello schienale.

Full lymph-draining and invigorating massage by air flux in the back and in the seat.

Massage total lympho-drainant par flux d'air a variation continue sur l'assise et sur le dossier.

ART. 3260 - 3270

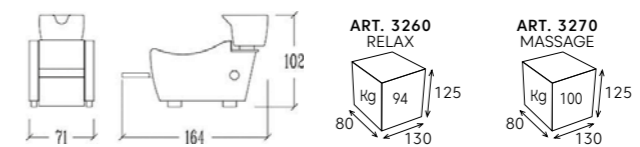



01 lavaggi - washings - lavages

curve - ART. 9805



Accesso facile.
Easy access.
Accès facile.

*
Disponibile
anche con
struttura grigia.
Available with
grey structure.
Disponibile avec
structure gris.

* **ART. 9805** - Piattaforma e colonnetta in materiale poliuretano, livello basculante supporto poltrona in vetroresina, tappezzeria in skai.
Base and column in polyurethane material, chair stand in fiberglass, tilting basin, upholstery in skai.
Plate forme et colonne en materiel poliurethane, cuvette basculante, structure du fauteuil en fibre de verre, tapisserie en skai.

ART. 9805

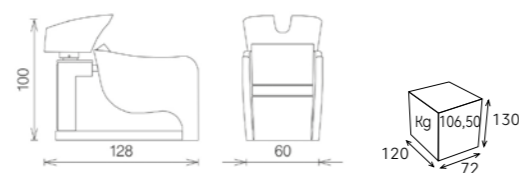

01 lavaggi - washings - lavages

curve relax - ART. 9806 - massage - ART. 9807



Utility - ART. 3815
Utility in acciaio inox con
vaschetta in ceramica
bianca, non incluso

Utility in steel with pottery
basin white, not included.

Utility en acier inox, basin en
ceramique blanc, pas inclus.



Poggiagambe regolabile
elettricamente fino alla
posizione relax.

Upholstery in skai, adjusting
leg rest by electronic.

Repose pieds réglable
jusqu'à la position relax.

* **ART. 9806** - Piattaforma e colonnetta in materiale poliuretano, livello basculante supporto poltrona in vetroresina, tappezzeria in skai.
Base and column in polyurethane material, chair stand in fiberglass, tilting basin, upholstery in skai.
Plate forme et colonne en materiel poliurethane, cuvette basculante, structure du fauteuil en fibre de verre, tapisserie en skai.

* **ART. 9807** - Massaggio totale linfodrenante a flusso d'aria a variazione continua su tutto il corpo.
Full lymph-draining and invigorating massage by air flux over the whole body.
Massage total lymph-drainant par flus d'air a' variation continue sur tout le corps.

ART. 9806 - 9807

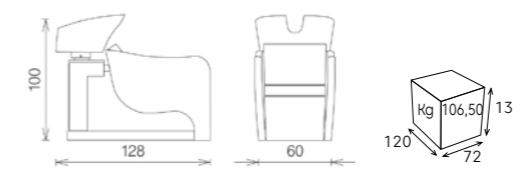

ART. 3815

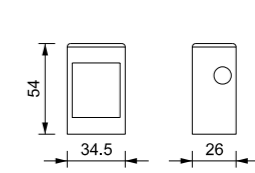



cooper - ART. 3280



Utility - ART. 3815

Utility in acciaio inox con vaschetta in ceramica bianca, non incluso

Utility in steel with pottery basin white, not included.

Utility en acier inox, basin en ceramique blanc, pas inclus.



ART. 3280 - Piattaforma e colonnetta in materiale poliuretano, livello basculante, tappezzeria in skai.

Base and column in polyurethane material, tilting basin, upholstery in skai.

Plate forme et colonne en materiel poliurethane, cuvette basculante, tapisserie en skai.

ART. 3280

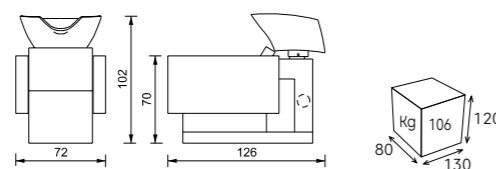

ART. 3815

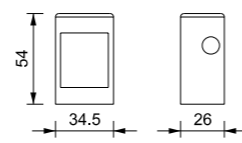

cooper relax - ART. 3285 - massage - ART. 3290 



optional
one touch



Alzagambe ad impulso automatico.

Automatic impulse leg lifters.

Leviers de jambes à impulsion automatique.

ART. 3285 - Poggiagambe regolabile elettricamente fino alla posizione relax.

Upholstery in skai, adjusting leg rest by electronic.

Repose pieds réglable jusqu'à la position relax.

ART. 3290 - Massaggio totale linfodrenante a flusso d'aria a variazione continua su tutto il corpo.

Full lymph-draining and invigorating massage by air flux over the whole body.

Massage total lympho-drainant par flux d'air a variation continue sur tout le corps.

ART. 3285 - 3290

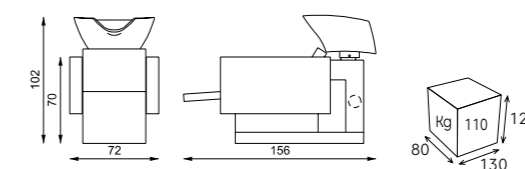

push-up relax - ART. 3350



***optional
one touch**
Alzagambe ad impulso automatico.

Automatic impulse leg lifters.

Leviers de jambes à impulsion automatique.



*** ART. 3350** - Lavaggio CERTIFICATO APAVE A NORME EUROPEE, lavello basculante, struttura completamente regolabile elettricamente in altezza. Poggiagambe regolabile elettricamente.

Washunit CERTIFIED BY APAVE, COMPLYING TO THE EUROPEAN REGULATIONS EN 14738. Electronic adjustment of the height of the complete system, electronic leg rest.

Bac certifié par APAVE EN RESPECT DE LA NORME EUROPEENNEEN14738. Reglage électrique en hauteur du dispositif entier. Repose-pieds réglable par l'électronique.

ART. 3350

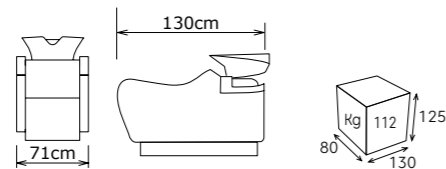

push-up massage - ART. 3360 **AIR MASSAGE**

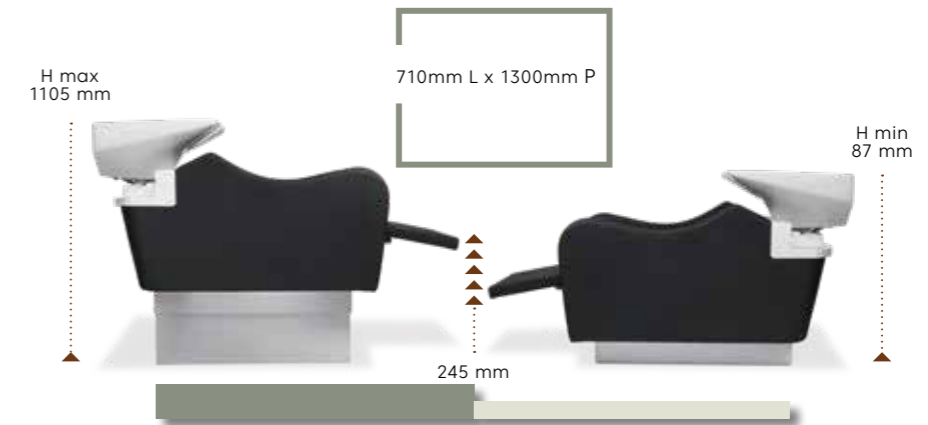

*** ART. 3360** - Lavaggio CERTIFICATO APAVE A NORME EUROPEE, lavello basculante, struttura completamente regolabile elettricamente in altezza. Poggiagambe regolabile elettricamente. Massaggio totale linfodrenante a flusso d'aria a variazione continua nella seduta e nello schienale.

Washunit CERTIFIED BY APAVE, COMPLYING TO THE EUROPEAN REGULATIONS EN 14738. Electronic adjustment of the height of the complete system, electronic leg rest. Full lymph-draining and invigorating massage by air flux in the back and in the seat.

Bac certifié par APAVE EN RESPECT DE LA NORME EUROPEENNEEN14738. Reglage électrique en hauteur du dispositif entier. Repose-pieds réglable par l'électronique. Massage total lympho-drainant par flux d'air à variation continue sur l'assise et sur le dossier.

ART. 3360

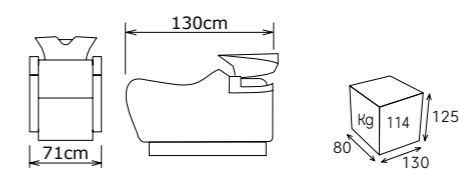

hop - ART. 3335



ART. 3335 - Lavello basculante, sotto lavello in materiale poliuretano con portashampoo incorporato, tappezzeria in skai.

Wash unit with tilting basin, frame in polyurethane material with shampoo holders, upholstery in skai.

Cuvette basculante, top posterior en materiel poliurethane blanc avec porte shampoings incorporée. Tapissierie en skai.

ART. 3335

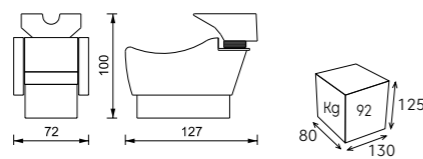

hop relax - ART. 3340 - massage - ART. 3345



optional one touch

Alzagambe ad impulso automatico.

Automatic impulse leg lifters.

Leviers de jambes à impulsion automatique.



ART. 3340 - Poggiagambe regolabile elettricamente per servizio relax.

Wash unit with electronic leg rest.

Repose pieds relax réglable par l'électronique.

ART. 3345 - Massaggio totale linfodrenante a flusso d'aria a variazione continua nella seduta e nello schienale.

Full lymph-draining and invigorating massage by air flux in the back and in the seat.

Massage total lympho-drainant par flus d'air a' variation continue sur l'assise et sur le dossier.

ART. 3340 - 3345

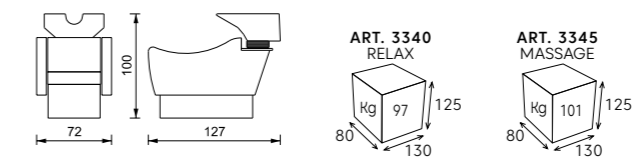



pod

pod - ART. 9001 - relax - ART. 9004 - massage - ART. 9003 



optional **one touch**



Alzagambe ad impulso automatico.
Automatic impulse leg lifters.
Leviers de jambes à impulsion automatique.

* **ART. 9001** - Struttura in materiale poliuretano color bianco, livello basculante, base acciaio lucido, tappezzeria in skai.
Frame in polyurethane material colour white, tilting basin, shine in steel base, upholstery in skai.
Structure en materiel poliurethane couleur blanc, cuvette basculante, base en acier brillant, tapisserie en skai.

* **ART. 9004** - Poggiagambe regolabile elettricamente.
Adjusting leg-rest by electronics.
Appui-jambes réglable par l'électronique.

* **ART. 9003** - Massaggio totale linfodrenante a flusso d'aria a variazione continua nella seduta e nello schienale.
Full lymph-draining and invigorating massage by air flux in the back and in the seat.
Massage total lymph-drainant par flus d'air a' variation continue sur l'assise et sur le dossier.

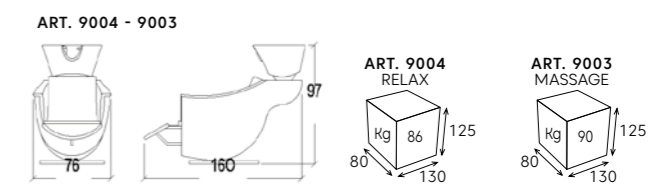

napoleone - ART. 3130 - napoleone III - ART. 3135



ART. 3130



ART. 3135



Utility - ART. 3180

Utility in acciaio inox con vaschetta in ceramica bianca, incluso.

Utility in steel with pottery basin white, included.

Utility en acier inox, basin en ceramique blanc, inclus.

ART. 3130 - Divano lavaggio, colonne in materiale poliuretano color bianco, lavello basculante, utility in acciaio con vaschetta in ceramica bianca, tappezzeria in skai.

Wash unit sofa, columns in polyurethane material colour white, tilting basin, utility in steel with pottery basin white, upholstery in skai.

Bac sofa, colonnes en materiel polyurethane couleur blanc, cuvette basculante, utility en acier avec basin en ceramique blanc, tapisserie en skai.

ART. 3135 - Divano lavaggio, colonne in materiale poliuretano color bianco, lavello basculante, utility in acciaio con vaschetta in ceramica bianca, tappezzeria in skai.

Wash unit sofa, columns in polyurethane material colour white, tilting basin, utility in steel with pottery basin white, upholstery in skai.

Bac sofa, colonnes en materiel polyurethane couleur blanc, cuvette basculante, utility en acier avec basin en ceramique blanc, tapisserie en skai.

ART. 3130

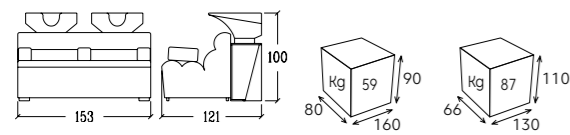

ART. 3135

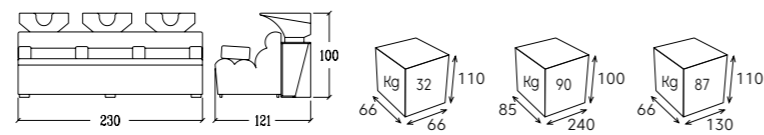

napoleone



dylan - ART. 3295



Utility - ART. 3815

Utility in acciaio inox con
vaschetta in ceramica
bianca, non incluso

Utility in steel with pottery
basin white, not included.

Utility en acier inox, basin en
ceramique blanc, pas inclus.

ART. 3295 - Struttura imbottita e ricoperta in skai, lavello basculante ,sotto lavello e scocca posteriore in materiale poliuretano.

Frame guilted and covered with skai, tilting white basin,under top and backside in polyurethane material.

Structure rembournée et recouverte en skai, couvette blanche et basculante, posterieur et top en materiel poliurethane.

ART. 3295

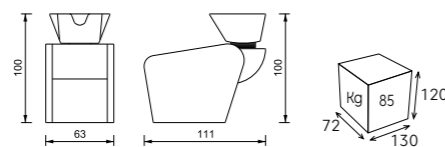

ART. 3815

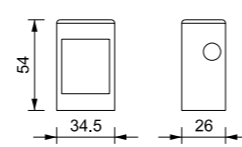

dylan relax - ART. 3300 - massage - ART. 3305 



ART. 3300 - Poggiagambe regolabile elettricamente,
tappezzeria in skai.

Adjusting leg-rest by electronics, upholstery in skai.
Appui-jambes réglable par l'électronique, tapisserie en skai.

ART. 3305 - Massaggio totale linfodrenante a flusso
d'aria a variazione continua su tutto il corpo.

Full lymph-draining and invigorating massage
by air flux over the whole body.

Massage total lympho-drainant par flus d'air
à variation continue sur tout le corps.

ART. 3300 - 3305

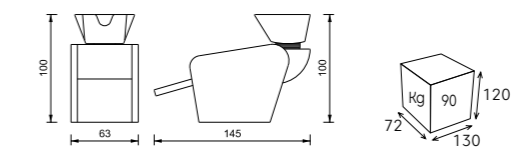

eddie - ART. 8060/16 - relax - ART. 8065/16 - massage - ART. 8069/16



*pannello



***pannello - ART. 3575**

Pannello copritubi in materiale poliuretano color nero, non incluso.

Panel for covering the pipes in polyurethane colour black, not included.

Panneau pour couvrir les tuyaux en matériel poliurethane couleur noir, non inclus.



*pannello

optional one touch



Alzagambe ad impulso automatico.

Automatic impulse leg lifters.

Leviers de jambes à impulsion automatique.

ART. 8060/16 - Struttura imbottita e ricoperta in skai, lavello bianco basculante, porta shampo posteriore, tappezzeria in skai.
Frame guilted and covered with skai, tilting white basin, shampoo holder on the backside, upholstery in skai.
Structure rembournée et recouverte en skai, cuvette blanche basculante, porte shampoings posterieur, tapisserie en skai.

ART. 8065/16 - Poggiagambe regolabile elettricamente, tappezzeria in skai.

Adjusting leg-rest by electronics, upholstery in skai.

Appui-jambes réglable par l'électronique, tapisserie en skai.

ART. 8069/16 - Massaggio totale linfodrenante a flusso d'aria a variazione continua nella seduta e nello schienale.

Full lymph-draining and invigorating massage by air flux in the back and in the seat.

Massage total lymph-drainant par flus d'air a' variation continue sur l'assise et sur le dossier.

ART. 8060/16

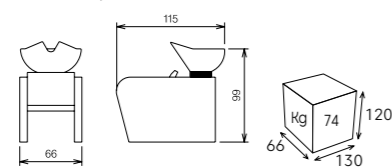

ART. 8065/16 - 8069/16

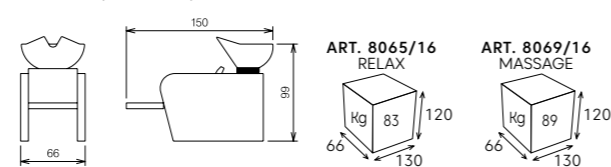

eddie sofà - ART. 8066 - sofà relax - ART. 8067 - sofà massage - ART. 8068



*pannello

optional one touch

Alzagambe ad impulso automatico.

Automatic impulse leg lifters.

Leviers de jambes à impulsion automatique.



*pannello



ART. 8066 - Divano lavaggio, struttura imbottita e ricoperta in skai, colore tappezzeria a scelta, lavello basculante, porta shampo posteriore.
Wash unit sofa, frame guilted and covered with skai, tilting white basin, shampoo holder on the backside, upholstery in skai.
Bac sofa, structure rembournée et recouverte en skai, cuvette blanche basculante, porte shampoings posterieur, tapisserie en skai.

ART. 8065/16 - Poggiagambe regolabile elettricamente, tappezzeria in skai.

Adjusting leg-rest by electronics, upholstery in skai.

Appui-jambes réglable par l'électronique, tapisserie en skai.

ART. 8069/16 - Massaggio totale linfodrenante a flusso d'aria a variazione continua nella seduta e nello schienale.

Full lymph-draining and invigorating massage by air flux in the back and in the seat.

Massage total lymph-drainant par flus d'air a' variation continue sur l'assise et sur le dossier.

ART. 8066

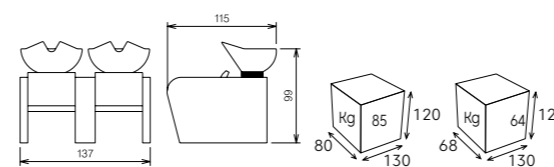

ART. 8067 - 8068

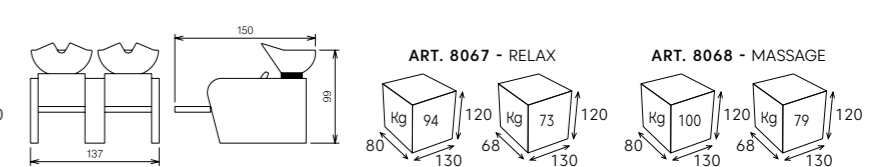



royal wash - ART. 8070



ART. 8070 - Struttura imbottita e ricoperta in skai, colore tappezzeria a scelta, lavello basculante, porta shampo posteriore.
 Frame guilted and covered with skai, tilting white basin, shampoo holder on the backside, upholstery in skai.
 Structure rembournée et recouverte en skai, cuvette blanche basculante, porte shampoings posterieur, tapisserie en skai.

ART. 8070

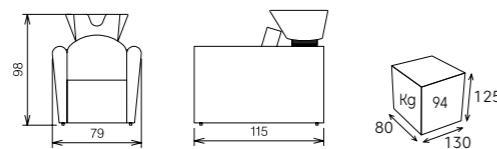

royal wash relax - ART. 8075 - massage - ART. 8077



optional one touch



Alzagambe ad impulso automatico.
 Automatic impulse leg lifters.
 Leviers de jambes à impulsion automatique.

ART. 8075 - Poggiagambe regolabile elettricamente, tappezzeria in skai.
 Adjusting leg-rest by electronics, upholstery in skai.
 Appui-jambes réglable par l'électronique, tapisserie en skai.

ART. 8077 - Massaggio totale linfodrenante a flusso d'aria a variazione continua nella seduta e nello schienale.
 Full lymph-draining and invigorating massage by air flux in the back and in the seat.
 Massage total lympho-drainant par flux d'air a variation continue sur l'assise et sur le dossier.

ART. 8075 - 8077

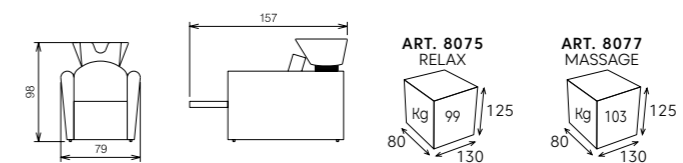



 **VEZZOSI**

02

poltrone lavoro
rotating chairs
fauteuils tournants



industrial

industrial chair - ART. 1306



ART. 1306 - Struttura in tubolare verniciato nero opaco. Tappezzeria in skai.
 Tubular structure matt black painted. Upholstery in skai.
 Structure tubulaire verni noir matt rembourrage en skai.

ART. 1306

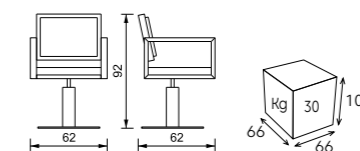

fancy - ART. 1410-P07 - 1410-P06



ART. 1410-P07 - verniciata oro, senza pompa - gold painted, without pump - peinte en or, sans pompe
ART. 1410-P06 - verniciata oro, con pompa - gold painted, with pump - peinte en or, avec pompe.

Struttura imbottita rivestita in skai, base in acciaio con pompa idraulica.

Polstered structure covered in skai, steel base with hydraulic pump.

Structure rembourrée recouverte de skai, base en acier avec pompe hydraulique.

ART. 1410-P07 - 1410-P06

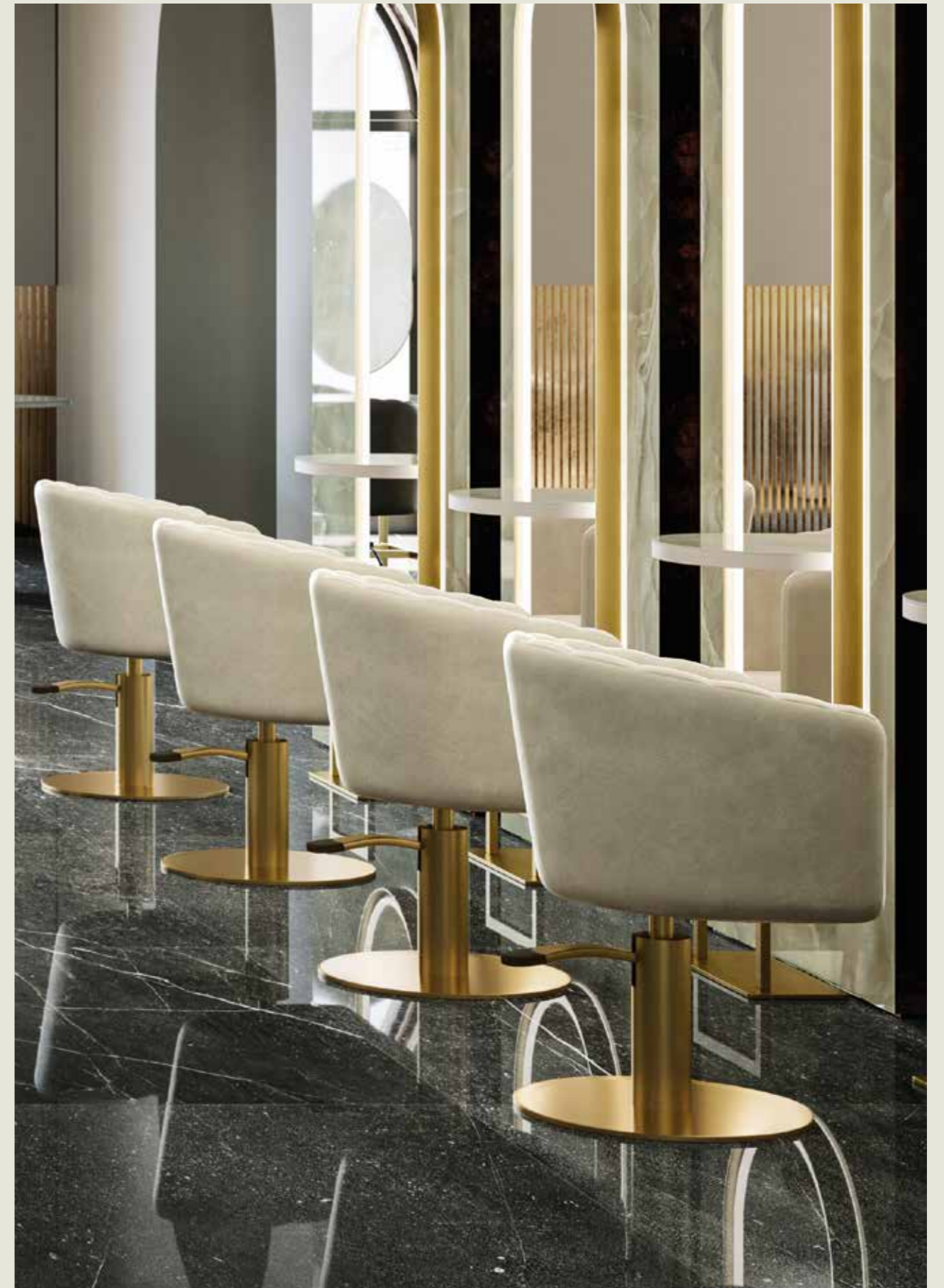
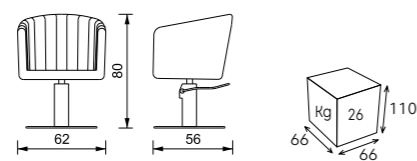

fancy

fancy - ART. 1410-P04



fancy



ART. 1410-P04 - verniciata nera, con pompa - black painted, with pump - peinte en noir, avec pompe.

Struttura imbottita rivestita in skai, base in acciaio con pompa idraulica.

Pholstered structure covered in skai, steel base with hydraulic pump.

Structure rembourrée recouverte de skai, base en acier avec pompe hydraulique.

ART. 1410 - 1410-P04

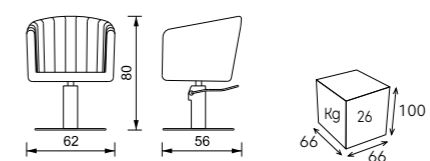

posh chair - ART. 1307



ART. 1307 - Struttura in tubolare verniciato oro. Tappezzeria in skai.
Tubular structure gold painted. Upholstery in skai.
Structure tubulaire verni or. Rembourrage en skai.

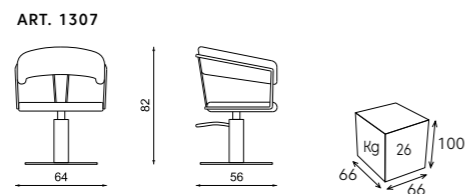

posh chair

posh black - ART. 1308



posh black



ART. 1308 - Struttura in tubolare verniciato nero opaco. Tappezzeria in skai.
Tubular structure matt black painted. Upholstery in skai.
Structure tubulaire verni noir matt. Rembourrage en skai.



ART. 1308

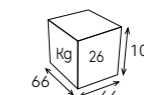
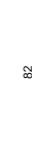
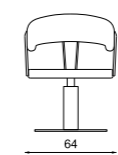

flora - ART. 1415-P05



ART. 1415-P05 - Struttura imbottita rivestita in skai, base in acciaio lucido con pompa idraulica.
Upholstered structure covered in skai, base in polished steel with hydraulic pump.
Structure rembourrée recouverte de skai, base en acier poli avec pompe hydraulique.

ART. 1415-P05

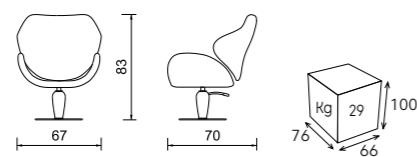

flora



iron

iron - ART. 1405 - 1406



Metallo grezzo.
Raw metal.
Metal brut.

ART. 1405 senza pompa - without pump - sans pompe - ART. 1406 con pompa - with pump - avec pompe

La particolarità di questa seduta risiede nella presenza di un meccanismo con pompa idraulica, il quale permette di gestire l'altezza in base alle esigenze del professionista.

The peculiarity of this seat is the presence of a mechanism with hydraulic pump, which allows you to manage the height according to the needs of the professional.

La particularité de cette chaise réside dans la présence d'un mécanisme avec pompe hydraulique, qui permet de gérer la hauteur en fonction des besoins du professionnel.

ART. 1405 - 1406

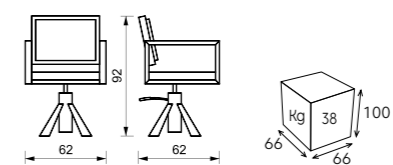

lupe - ART. 1300



ART. 1300 - Struttura in acciaio verniciato grigio, tappezzeria in skai.
Frame in painted steel grey, upholstery in skai.
Structure en acier verni gris, tapisserie en skai.

ART. 1300

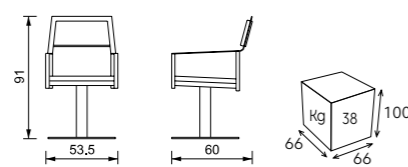

CUIVE - ART. 9855 - 9856



ART. 9855 senza pompa - without pump - sans pompe - **ART. 9856** con pompa - with pump - avec pompe

Base acciaio lucido, struttura in vetroresina bianca lucidata, con pompa idraulica, tappezzeria in skai.

Shine steel base, frame in shine white fiberglass, with hydraulic pump, upholstery in skai.

Base en acier brillant, structure en fibre de verre couleur blanc brillant, avec pompe hydraulique, tapisserie en skai.

ART. 9855 - 9856

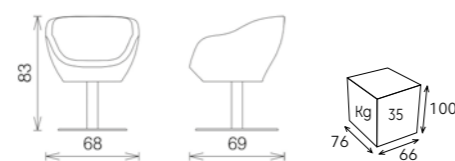

CUIVE - ART. 9850 - 9851



ART. 9850 senza pompa - without pump - sans pompe - **ART. 9851** con pompa - with pump - avec pompe

Base acciaio lucido, struttura in vetroresina bianca lucidata, con pompa idraulica, tappezzeria in skai.

Shine steel base, frame in shine white fiberglass, with hydraulic pump, upholstery in skai.

Base en acier brillant, structure en fibre de verre couleur blanc brillant, avec pompe hydraulique, tapisserie en skai.

ART. 9850 - 9851

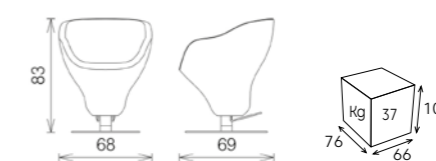

funky - ART. 9315



funky



ART. 9315 - Struttura completamente rivestita in skai.
Structure completely upholstered in skai.
Structure completement couverte en skai.

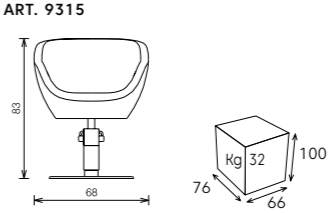

meg - ART. 8145



ART. 8145 - Struttura in poliuretano espanso con inserto interno in acciaio, tappezzeria in skai.
Frame in moulded expanded polyurethane with steel frame, upholstery in skai.
Structure en polyurethane avec structure en acier, tapisserie en skai.

ART. 8145

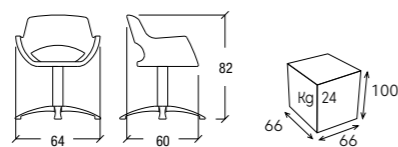

s-chair - ART. 9310



s-chair



ART. 9310 - Struttura in metallo interamente ricoperta in skai.
Metal structure completely covered in skai.
Structure metallique completement couvert en skai.



ART. 9310

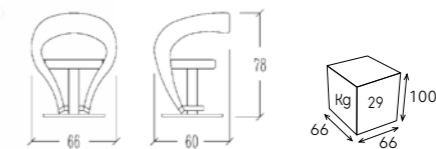

carnaby - ART. 1396



ART. 1396 - Imbottitura in poliuretano espanso, tappezzeria in skai.
Structure in polyurethane material , upholstery in skai.
Structure en materel polyrethane, tapisserie en skai.

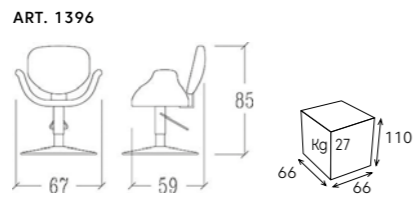

dora - ART. 1310



ART. 1310 - Struttura in poliuretano espanso, tappezzeria in skai.
Frame in mouled expanded polyurethane, upholstery in skai.
Structure en polyurethane, tapisserie en skai.

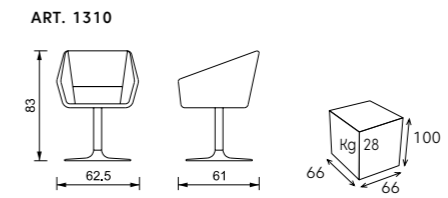

epoque - ART. 9311



ART. 9311 - Struttura completamente rivestita in skai, colore tappezzeria a scelta.
Structure completely covered in skai at choice.
Structure complètement couverte en skai à choix.

ART. 9311

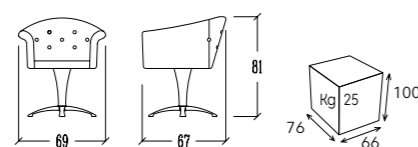

epoque



piccadilly

piccadilly - ART. 1398



ART. 1398 - Imbottitura in poliuretano espanso, tappezzeria in skai.
 Structure in polyurethane material , upholstery in skai.
 Structure en materel polyrethane, tapisserie en skai.

ART. 1398

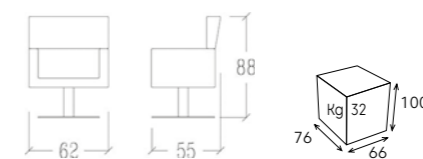

Uma - ART. 1350



ART. 1350 - Struttura in poliuretano espanso con inserto interno in acciaio, tappezzeria in skai.
Frame in moulded expanded polyurethane with steel frame, upholstery in skai.
Structure en polyurethane avec structure en acier, tapisserie en skai.

ART. 1350

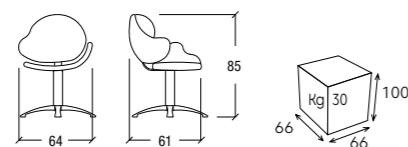

devil - ART. 1327



ART. 1327 - Struttura completamente rivestita in skai.
 Structure completely upholstered in skai.
 Structure completement couverte en skai.



ART. 1327

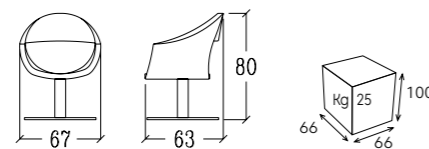

apple - ART. 8136



ART. 8136 - Struttura in acrilico trasparente, cuscino in skai colore a scelta.
 Frame in transparent acrylic, seat in skai colour at choice.
 Structure en acrilic ransparent, assise en skai couleur à choix.

ART. 8136

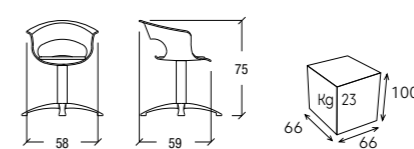



royal

royal - ART. 8125



ART. 8125 - Struttura completamente rivestita in skai, colore tappezzeria a scelta.
 Structure completely covered in skai at choice.
 Structure complètement couverte en skai à choix.

ART. 8125

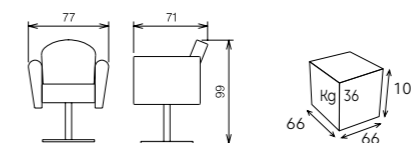

trafalgar - ART. 8175



ART. 8175 - Struttura in multistrato di faggio, imbottitura in poliuretano espanso, rivestita in skai.
 Frame in multi-ply beech, covered by moulded polyurethane, upholstery in skai.
 Structure multicouche de hêtre, rembourrage en polyurethane, tapisserie en skai.

ART. 8175

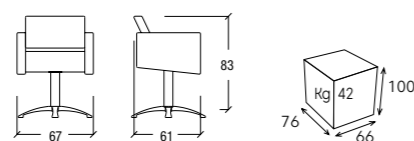

oxford - ART. 1397



ART. 1397 - Imbottitura in poliuretano espanso, tappezzeria in skai.
 Structure in polyurethane material, upholstery in skai.
 Structure en materiel polyrethane, tapisserie en skai.

ART. 1397

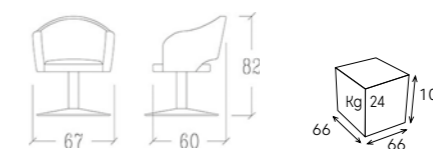

frida - ART. 1320



ART. 1320 - Struttura in metallo verniciato , tappezzeria in skai.
Frame in painted metal, upholstery in skai.
Structure en metal verni, tapisserie en skai.

ART. 1320

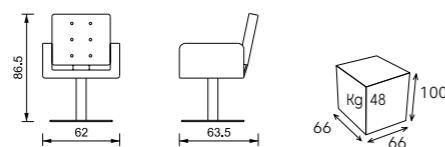

eva - ART. 1321



ART. 1321 - Poggiapiede in metallo verniciato, poggiatesta regolabile, schienale reclinabile, tappezzeria in skai.
Foot-rest in painted metal, adjustable headrest, reclining backrest, upholstery in skai.
Repose pieds en metal verni, appuie tete réglable, dossier inclinable, tapisserie en skai.

ART. 1321

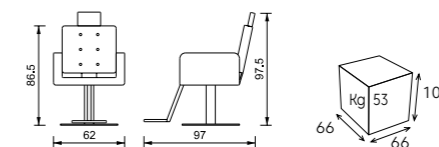



LEYTONSTONE
LEYTONSTONE HARROW GREEN
PLAISTOW STATION
STRATFORD
VICTORIA & ALBERT DOCKS
VIA GREENGATE
WALTHAMSTOW CENTRAL STN
WALTHAMSTOW CROOKED BILLET
WALTHAMSTOW GARAGE
WATERLOO
WEST HAM GARAGE
WHIPPS CROSS

OPERA
MUSEE DU LOUVRE
NOTRE-DAME
MUSEE D'ORSAY
CONCORDE
CHAMPE-ELYSEES
ARC DE TRIUMPH
TROCADERO
TOUR EIFFEL
INVALIDES

PIAZZA SPAGNA
COLOSSEO
OTTAVIANO
FORO ROMANO
PANTHEON
FONTANA TREVII
PIAZZA PRISCILLA
PONTE SANT ANGELO

FLAMINIO
SPAGNA
BARBERINI
REPUBBLICA
VITTORIO EMANUELE
MANZONI
SAN GIOVANNI
RE DI ROMA
PONTE LUNGO

dandy - ART. 8169



ART. 8169 - Poltrona barbiere con carter laterale e basamento colore bianco lucido o nero lucido, schienale reclinabile, poggiatesta e poggipiedi regolabili, colore tappezzeria a scelta.

Barber chair, sides and foot white or black, adjusting headrest and leg rest, upholstery in skai at choice.

Barber fauteuil, côtés latérales et pied blanc ou noir brillant, dossier reclinable, repose tête et repose pieds réglables, tapissérie en skai couleurs à choix.

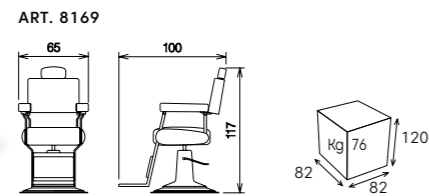

newton plus - ART. 9314



ART. 9314 - Struttura rivestita in skai, colore a scelta, tappezzeria decorata tipo trapunta, poggiatesta regolabile, schienale reclinabile, poggipiedi incorporato.

This structure is upholstered with skai fabrics at choice, upholstery embroidered, adjustable headrest, reclining backrest, foot/rest incorporated.

Structure et revêtement en skai couleurs à choix, tapissérie brodée, appuie-tête réglable, dossier inclinable, repose-pieds incorporée.

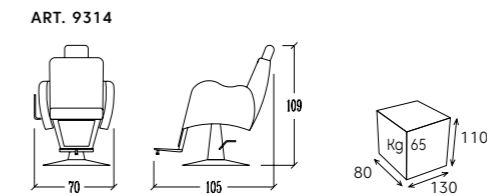

gingerman - ART. 1326



ART. 1326 - Struttura rivestita in skai, poggiatesta regolabile, schienale reclinabile, poggipiedi incorporato.
This structure is upholstered with skai fabrics, adjustable headrest, reclining backrest, foot/rest incorporated.
Structure et revetement en skai, appuie-tete réglable, dossier inclinabile, repose/pieds incorporee.



ART. 1326

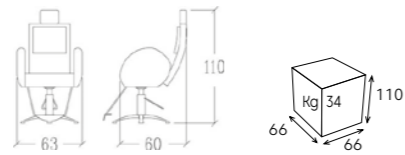

adam - ART. 1322



ART. 1322 - Struttura in metallo verniciato, poggiatesta regolabile, schienale e poggipiedi reclinabili.
Frame in painted metal, adjustable headrest, backrest and foot rest reclining.
Structure en metal verni, appuie tete réglable, dossier et repose pieds inclinables.

ART. 1322

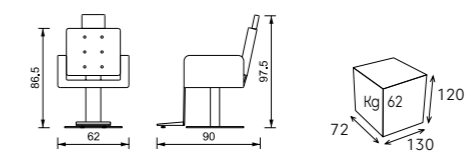



03

posti lavoro
styling units
coiffeuses

 **VEZZOSI**



industrial island - ART. 4016



ART. 4016 - Struttura in ferro verniciato nero opaco. Piano lavoro in laminato effetto legno noce pacifico tabacco.
Frame in matt black painted steel, top in wood effect laminate noce pacifico tabacco.
Structure en acier peint couleur noir matt, top en stratifié plastique effect bois noce pacifico tabacco.

ART. 4016

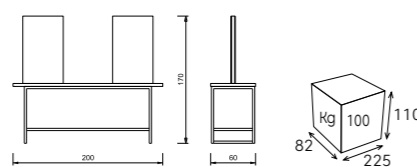



industrial

industrial - ART. 4017



ART. 4017 - Struttura in ferro verniciato nero opaco. Piano lavoro in laminato effetto legno noce pacifico tabacco.
Poggiapiedi in metallo verniciato.

Frame in mat black painted steel, top in wood effect laminate noce pacifico tabacco. Foot-rest in painted metal.
Structure en acier peint couleur noir matt, top en stratifié plastique effect bois noce pacifico tabacco. Repose-pieds en metal verni.

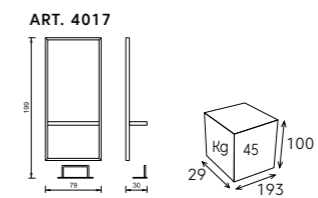



posh double - ART. 4018



ART. 4018 - Specchi circolari, con fascia sabbiata retroilluminata a led, bordo in laminato effetto oro, basamento in acciaio oro e tubolare verticale verniciato oro. Poggiapiedi inclusi.

Circular mirrors, with led backlit sandblasted band, on gold effect laminate edge, gold steel base and gold painted vertical tube. Footrests included.

Miroirs circulaires, avec bande sablée rétroéclairée par led, bord en stratifié effet or, base en acier or et tube vertical or verni. Repose-pieds inclus.

ART. 4018

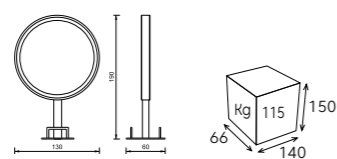

posh double



posh

posh - ART. 4019

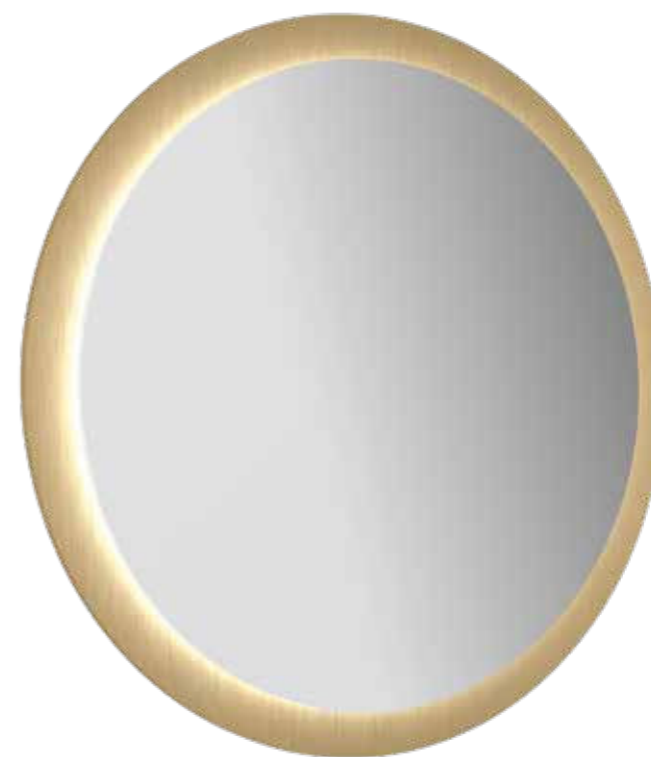

ART. 4019 - Specchio circolare retro illuminato a led, su pannello tondo in laminato color oro, poggia piede non incluso.

Circular mirror with led backlit, round panel in gold laminated, footrest not included.
Miroir circulaire rétroéclairée par led, panneau en stratifié or, repose-pieds non inclus.

ART. 4019

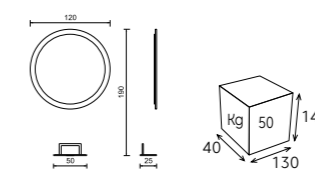

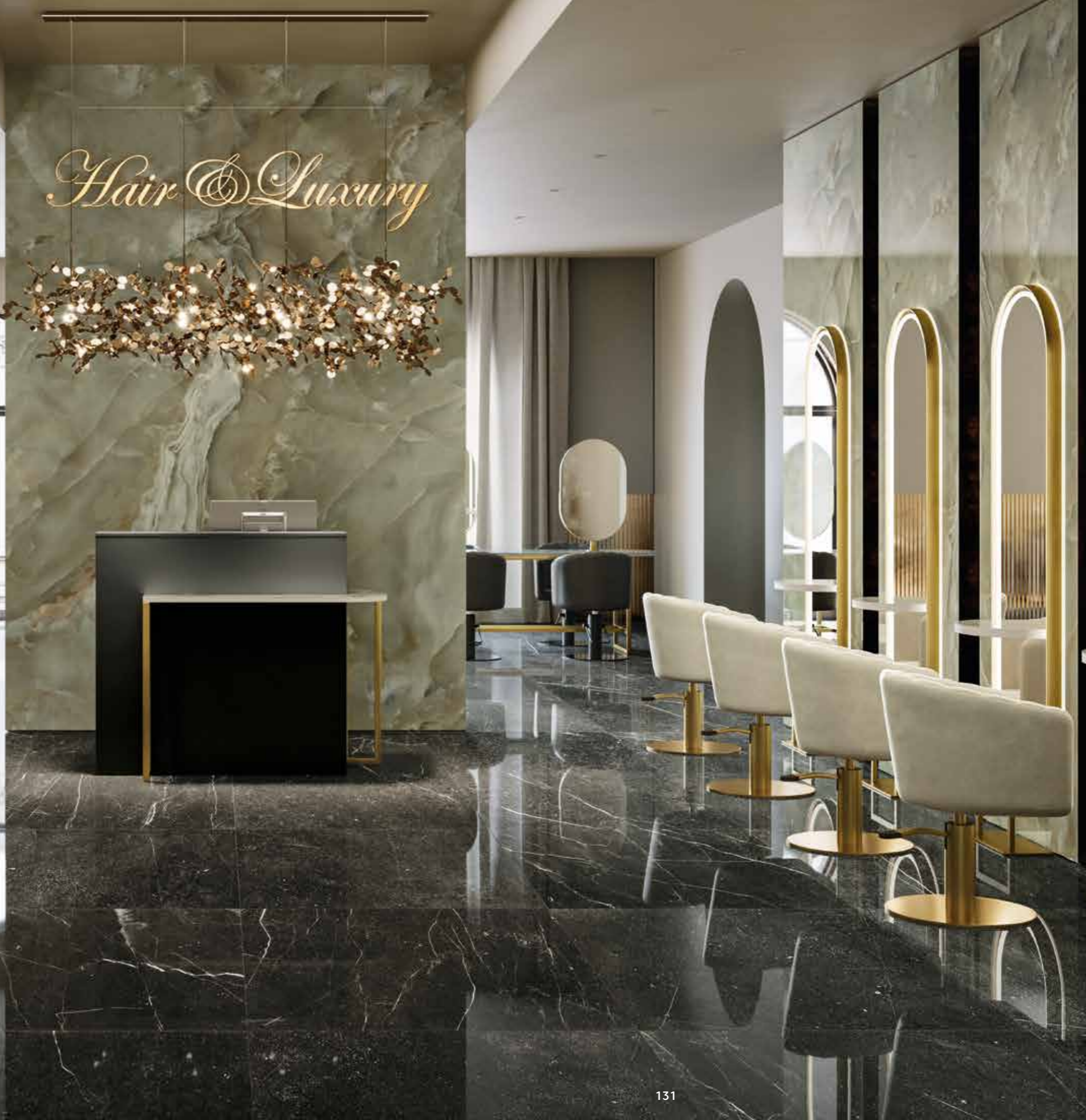

fancy doppio - ART. 4110 - con piano lavoro - ART. 4110/M



Gres porcellanato per pianetto.
Porcelain stoneware for top.
Grès cérame pour plateau.

ART. 4110/M

ART. 4110 - Cornice in acciaio verniciato color oro, specchio con fascia sabbata retroilluminata a led. Poggiapiedi in acciaio verniciati color oro.
Frame in gold painted steel, mirror with sandblasted strip backlit by led. Footrest in gold painted steel.
Cadre en acier peint or, miroir avec bande sablée rétroéclairée par led. Repose-pieds en acier peint or.

ART. 4110/M con piano lavoro - with top - avec tablette - Cornice in acciaio verniciato color oro, specchio con fascia sabbata retroilluminata a led, pianetto in gres porcellanato, color onice, su supporto in laminato plastico. Poggiapiedi in acciaio verniciati color oro.
Gold-colored painted steel frame, mirror with sandblasted LED backlit band, porcelain stoneware top, onyx color, on plastic laminate support. Footrest in gold painted steel.

Cadre en acier peint couleur or, miroir avec bande sablée rétroéclairée par LED, plateau en grès cérame couleur onyx, sur un support en stratifié plastique. Repose-pieds en acier peint

ART. 4110

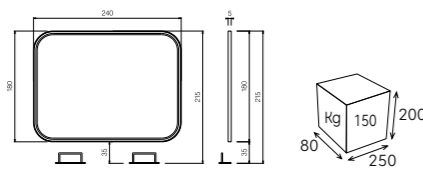

ART. 4110/M

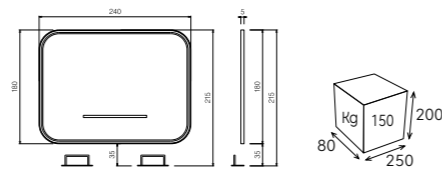

fancy

fancy centrale 4 posti - ART. 4113



fancy



ART. 4113 - Telaio in acciaio verniciato color oro, piano in gres porcellanato, color onice, su supporto in laminato plastico, tunnel porta prese sottopiano in laminato plastico, specchi su supporto in laminato plastico sorretti da telai in acciaio verniciati color oro.
 Gold-colored steel frame, onyx-colored porcelain stoneware top on plastic laminate support, plastic laminate undertop socket tunnel, mirrors on plastic laminate support supported by gold-painted steel frames.

Structure en acier verni or, plateau en grès cérame, couleur onyx, sur support en stratifié plastique, tunnel douille sous plateau en stratifié plastique, miroirs sur support en stratifié plastique soutenus par des cadres en acier verni or.

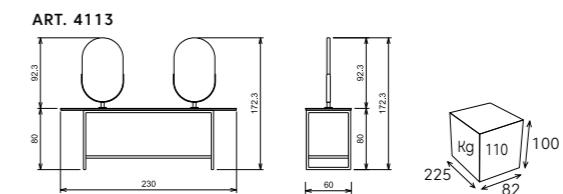

fancy singolo - ART. 4111



ART. 4111 - Cornice in acciaio verniciato color oro, specchio con sabbiatura retroilluminata a led, pianetto in gres porcellanato, color onice, su supporto in laminato plastico. Poggiapiedi in acciaio verniciato color oro.

Frame in gold-colored painted steel, mirror with LED backlit sandblasting, top in onyx-colored porcelain stoneware, on plastic laminate support. Footrest in gold-colored painted steel.

Structure en acier peint couleur or, miroir avec sablage rétroéclairé par LED, plateau en grès cérame couleur onyx, sur support en stratifié plastique. Repose-pieds en acier peint or.

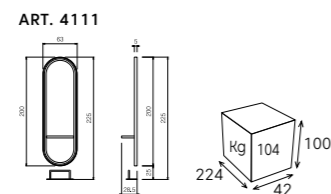



flora

flora doppio - ART. 4114



ART. 4114 - Specchi circolari, con fascia sabbiata retroilluminata a led, bordo in laminato effetto specchio, basamento in acciaio lucido e tubolare verticale cromato. Portaphon cromati inclusi. Poggiapiedi inclusi.

Circular mirrors, with LED backlit sandblasted band, on mirror effect laminate edge, polished steel base and chromed vertical tube. Chrome-plated hair dryer holders included. Footrests included.
Miroirs circulaires, avec bande sablée rétroéclairée par LED, bord en stratifié effet miroir, base en acier poli et tube vertical chromé. Supports de sèche-cheveux chromés inclus. Repose-pieds inclus.

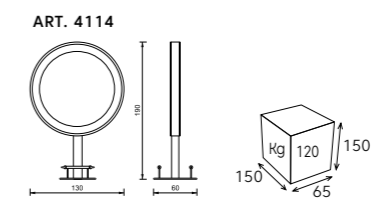

flora singolo - ART. 4115

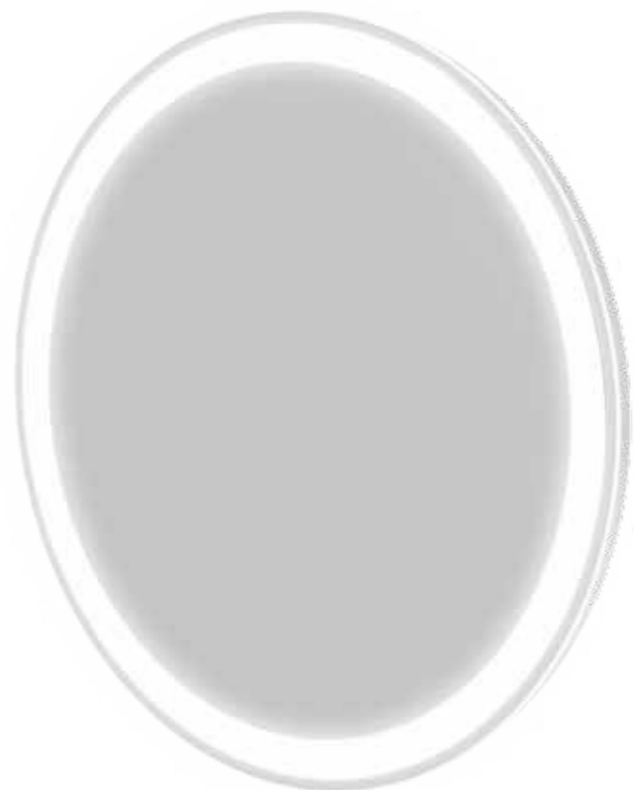

ART. 7340

ART. 4115 - Specchio circolare con fascia sabbata e retroilluminata a led, poggiatesta non incluso.

Circular mirror with sandblasted and LED backlit band, footrest not included.

Miroir circulaire avec bande sablée et rétroéclairée par LED, repose-pieds non inclus.

ART. 7340 - Poggiatesta in acciaio e alluminio lavorato.

Foot-rest in steel and aluminium.

Repose-pieds en acier et aluminium.

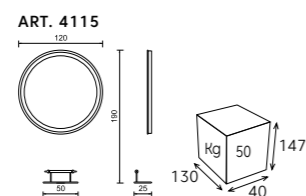





cleopatra

cleopatra - ART. 4105



ART. 4105 - Centrale bifacciale, illuminazione incorporata, contorno in plexiglass serigrafato, base in acciaio lucido, supporto in tubo acciaio cromato. Poggiapiedi incluso. Poggiapiedi indicati tipo art. 7300 o 7340. **Vedi listino.**

Free standing double styling unit, lighting incorporated, outline in plexiglass with decoration, base in shine steel, tube in chromium plated steel. Foot rest included. Foot-rest indicated art. 7300 or 7340. **See price list.**

Centrale double face, illumination incorporé, contour en plexiglass décoré base en acier brillant, tube en acier chromé. Repose pieds inclus. Repose pieds indiqué art. 7300 ou 7340. **Voir la liste de prix.**

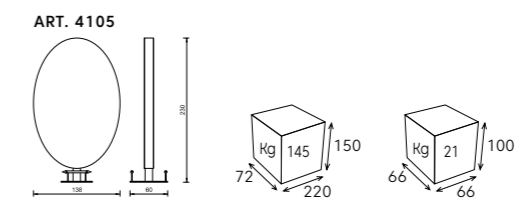

cleopatra wall - ART. 4100



ART. 7340

ART. 4100 - Posto lavoro con illuminazione incorporata, contorno in plexiglass serigrafato, base in acciaio lucido, supporto in tubo acciaio cromato. Poggiapiedi non incluso.

Styling unit with lighting incorporated, outline in plexiglass with decoration, base in shine steel, tube in chromium, plated steel. Foot rest not included.

Coiffeuse avec illumination incorporée, contour en plexiglass décoré base en acier brillant, tube en acier chromé. Repose pieds pas inclus.

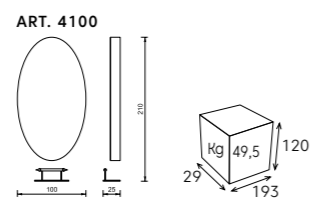

cleopatra wall



epoque wall - ART. 9327



ART. 9327 - Specchiera in vetro fuso, finitura in vetro extrachiario trasparente, specchio centrale a filo lucido illuminazione a led incorporata, piano lavoro in laminato, poggiapiedi inclusi.

Looking glass in melted glass, finish in transparent extralight glass, central mirror lighting by led incorporated, top in plastic laminated, foot-rests included.

Glace en verre fondu finissage en verre transparent extralight, miroir central, éclairage decorative à led incorporée, top en stratifié, repose pieds inclus.

ART. 9327

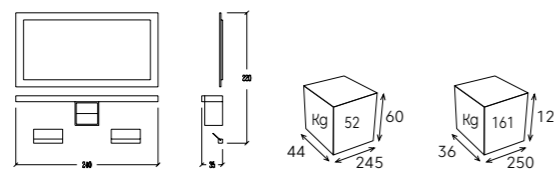

epoque wall

epoque 1 - ART. 9330



ART. 9330 - Specchiera in vetro fuso, finitura in vetro extrachiaro trasparente, specchio centrale a filo lucido illuminazione a led incorporata, piano lavoro in laminato, poggiapiedi inclusi.

Looking glass in melted glass, finish in transparent extralight glass, central mirror lighting by led incorporated, top in plastic laminated, foot-rests included.

Glace en verre fondu finissage en verre transparent extralight, miroir central, éclairage decorative à led incorporée, top en stratifié, repose pieds inclus.

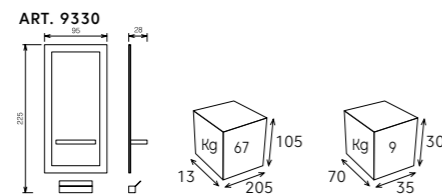

epoque 1



stripe - ART. 8217/16 - stripe light - ART. 8218/16



ART. 8217/16 senza illuminazione - without light - sans éclairage
Decorazione laterale, piano lavoro in laminato bianco o nero, poggiapiedi non incluso.
Lateral decoration, top in white or black laminated, foot rest not included.
Décoration latérale, tablette en stratifié blanc ou noir, repose pieds pas inclus.

ART. 8218/16 - Decorazione laterale retroilluminata, piano lavoro in laminato bianco o nero, poggiapiedi non incluso.
Lateral decoration with light, top in white or black laminated, foot rest not included.
Décoration latérale retro éclairée, tablette en stratifié blanc ou noir, repose pieds pas inclus.

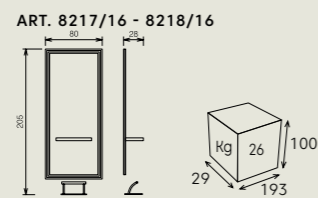

stripe light



one light

one light - ART. 8234/16



ART. 8234/16 - Modulo a un posto lavoro con illuminazione a led sui 4 lati.
Piano lavoro in nobilitato bianco o nero, poggiatesta non incluso.

Single styling unit with led light in the 4 sides,
top in white or black pre-laminated, foot-rest not included.

Coiffeuse individuelle avec éclairage à led dans les 4 côtés,
tablette en mélaminé blanc ou noir, repose pieds pas inclus.

Colori per piano lavoro.
Colors for shelf.
Couleurs pour tablette.



ART. 8234/16

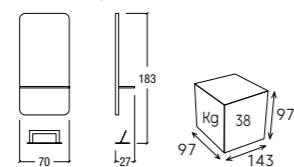

dos light - ART. 8236/16



ART. 8236/16 - Modulo a 2 posti con illuminazione a led sui 4 lati.
Piano lavoro in nobilitato bianco o nero, poggiatesta non incluso.

Double styling unit with led light in the 4 sides,
top in white or black pre-laminated, foot-rest not included.

Place de travail deux places avec éclairage à led dans les 4 côtés,
tablette en mélaminé blanc ou noir, repose pieds pas inclus.

ART. 8236/16

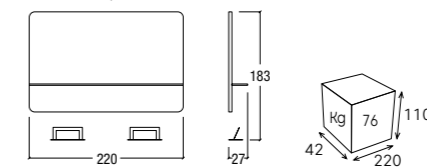

Colori per piano lavoro.
Colors for shelf.
Couleurs pour tablette.

bianco lucido nero lucido

new york - ART. 4015



ART. 4015 - cornice in acciaio verniciato color nero opaco,
specchio con sabbiatura retroilluminata a led, pianetto in laminato plastico. poggiapiedi in acciaio verniciato.
Frame in black-colored painted steel, mirror with led backlit sandblasting, top in laminate . Footrest in steel.
Structure en acier peint couleur noir, miroir avec sablage rétroéclairé par led, plateau en stratifié plastique. Repose-pieds en acier.

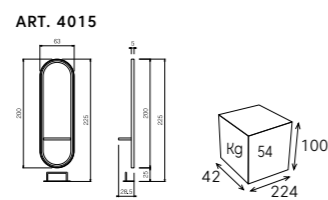



brooklyn

03 posti lavoro - styling units - coiffeuses

brooklyn - ART. 4109



ART. 4109 - Il legno domina la scena in quello che è il posto lavoro Brooklyn. Il tavolo presenta un comodo mobiletto centrale e il top è realizzato interamente in laminato plastico effetto legno. Completano la postazione specchiere perfettamente tonde rifinite con fasce in cuoio naturale.

Wood dominates the scene in the Brooklyn work station. The table has a comfortable central cabinet and the top is made entirely of wood-effect plastic laminate. The workstation is completed by perfectly round mirrors finished with natural leather bands.

Le bois domine la scène dans le poste de travail Brooklyn. La table est dotée d'un meuble central très pratique et le plateau est entièrement réalisé en stratifié plastique effet bois. Des miroirs parfaitement ronds terminés par des bandes de cuir naturel complètent le poste de travail.

ART. 4109

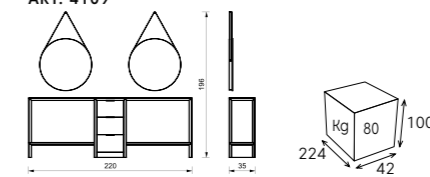

iron - ART. 4108 - ART. 4108L

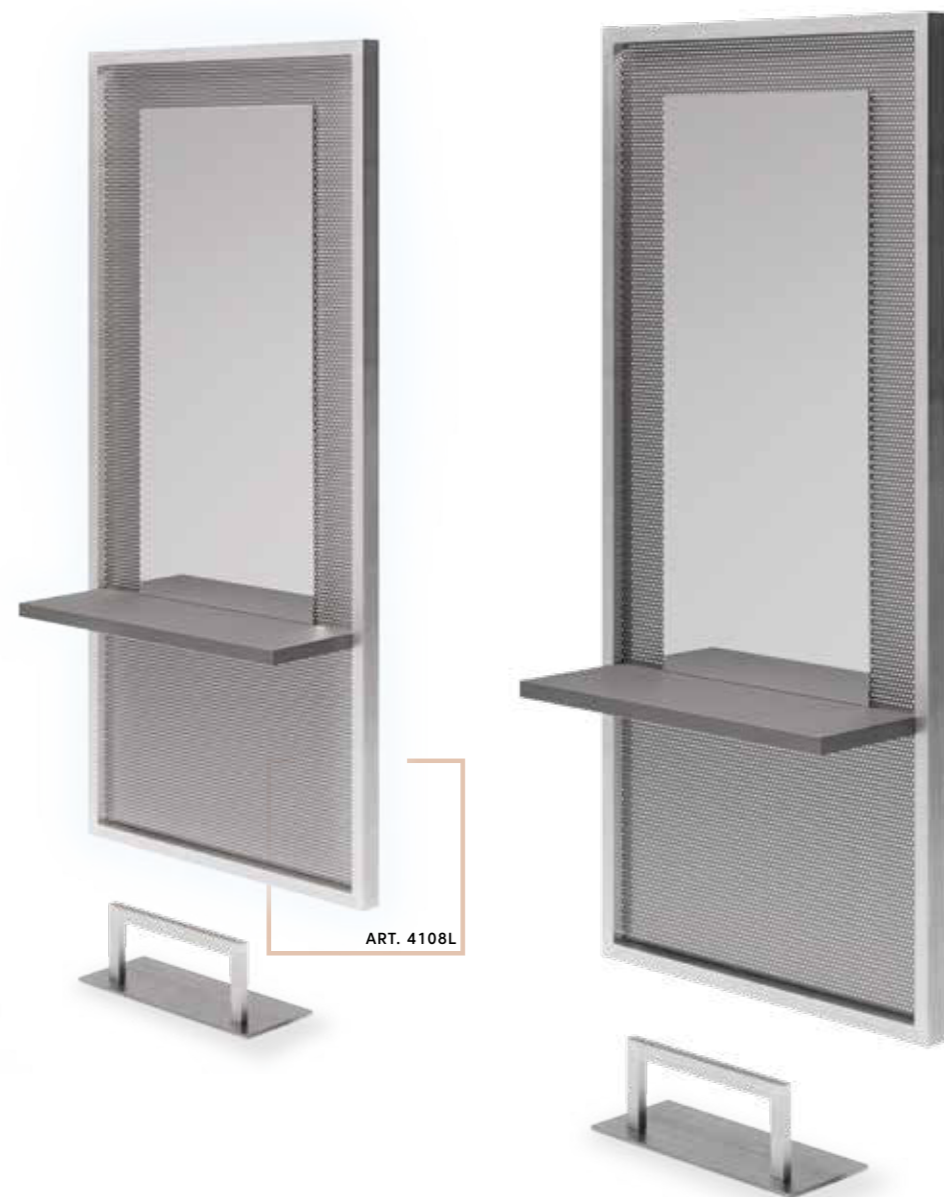

ART. 4108 - Il posto lavoro con specchio quadrato della collezione Iron è la perfetta essenza dello stile urban, grazie a un raffinato effetto metallizzato dato da una fitta rete particolarmente moderna e minimal. L'assenza di un appoggio a terra rende la struttura leggera e incornicia alla perfezione lo spazio in cui è inserita.

The workstation with square mirror of the Iron collection is the perfect essence of urban style, thanks to a refined metallic effect given by a particularly modern and minimal thick wire mesh. The absence of a floor support makes the structure light and perfectly frames the space in which it is inserted.

La coiffeuse avec miroir carré de la collection Iron est l'essence parfaite du style urbain, grâce à un effet métallique raffiné donné par une maille particulièrement moderne et minimale. L'absence de base se support à terre sol rend la structure légère et encadre parfaitement l'espace dans lequel elle s'insère.

ART. 4108L con illuminazione - with lighting - avec éclairage - Il sistema d'illuminazione incorporata della postazione lavoro Iron è pensata per donare all'intera struttura maggiore risalto. L'effetto grezzo e industriale della maglia metallica s'intensifica grazie al gioco di luci e ombre che i LED aiutano a creare.

The built-in lighting system of the Iron workstation is designed to give the entire structure greater prominence. The raw and industrial effect of the metal mesh is intensified thanks to the play of light and shadow that the LED lights help creating.

Le système d'éclairage intégré de la station de travail Iron est conçu pour mettre en valeur l'ensemble de la structure. L'effet brut et industriel de la maille métallique est intensifié grâce au jeu d'ombre et de lumière que les LED contribuent à créer.

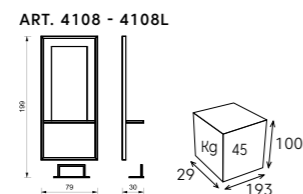



eden - ART. 8275



ART. 8275 - Centrale bifacciale, struttura in laminato acciaio, base acciaio lucido e supporto in tubo acciaio cromato lucido. Poggiapiedi incluso. Poggiapiedi indicati tipo art. 7300 o 7340. **Vedi listino.**

Free standing double styling unit, structure en shine steel laminate, base in shine steel, stem in chromium plated steel. Foot rest included. Foot-rest indicated art. 7300 or 7340. **See price list.**

Centrale double face, structure en stratifié' acier brillant, base en acier brillant, tige en acier chromé. Repose pieds inclus. Repose pieds indiqué art. 7300 ou 7340. **Voir la liste de prix.**

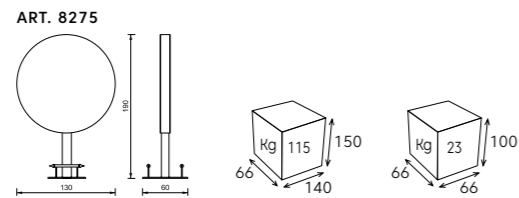

eden+ - ART. 8275P



ART. 8275P - Centrale bifacciale, struttura in laminato acciaio, base acciaio lucido e supporto in tubo acciaio cromato lucido. Piano lavoro in legno laccato. Poggiapiedi incluso. Poggiapiedi indicati tipo art. 7300 o 7340. **Vedi listino.**

Free standing double styling unit, structure en shine steel laminate, base in shine steel, stem in chromium plated steel. Top in laquered wood. Foot rest included. Foot-rest indicated art. 7300 or 7340. **See price list.**

Centrale double face, structure en stratifié' acier brillant, base en acier brillant, tige en acier chromé. Tablette en bois laqué. Repose pieds inclus. Repose pieds indiqué art. 7300 ou 7340. **Voir la liste de prix.**

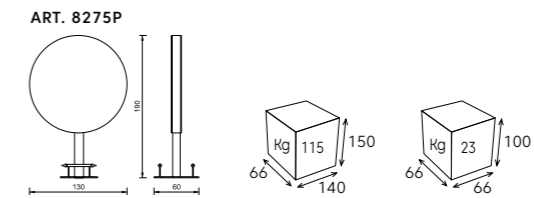



s-wall

s-wall - ART. 5150



ART. 5150 - Struttura in poliuretano rigido trattato con vernice antimacchia, poggiatesta incluso.
 Structure in polyurethane treated with stainproof, footrest included.
 Structure en materiel poliurethane traité avec peinture anti tache, repose pieds inclus.

ART. 5150

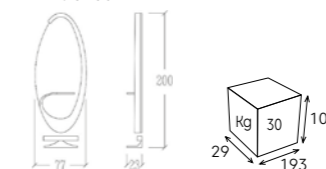

felipe - ART. 4039



ART. 4039 - Struttura in laminato, completo di specchi e poggiatesta.
 Structure in laminated, mirrors and foot rest included.
 Structure en stratifié, miroirs et repose pieds inclus.

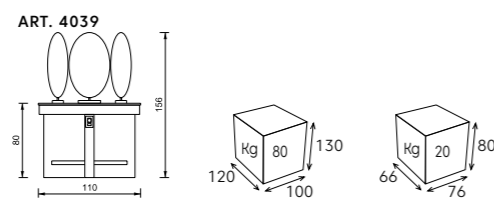

polaris - ART. 5180



ART. 5180 - Tavolo centrale 4 posti lavoro, struttura in laminato plastico, poggiatesta in acciaio.
 Table 4 places, structure in plastic laminated, foot rest in steel.
 Table 4 places, structure en stratifié, repose pieds en acier.

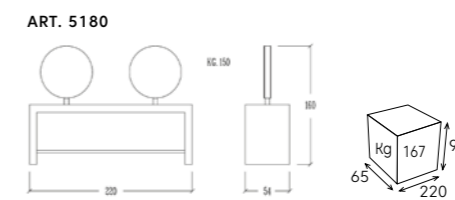

polaris+ - ART. 5181

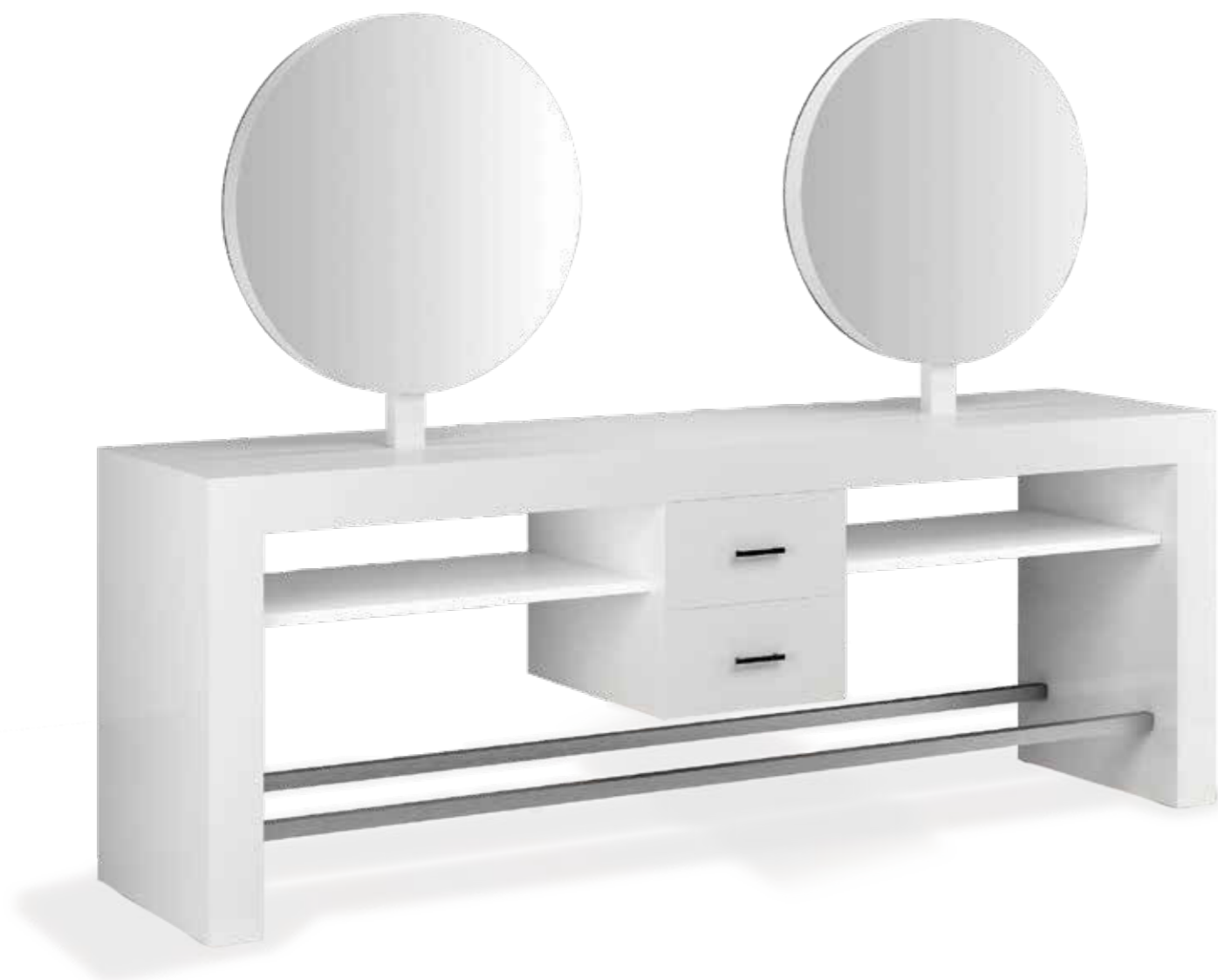

ART. 5181 - Tavolo centrale 4 posti lavoro, struttura in laminato plastico, poggiapiede in acciaio.
 Table 4 places, structure in plastic laminated, foot rest in steel.
 Table 4 places, structure en stratifié, repose pieds en acier.

ART. 5181

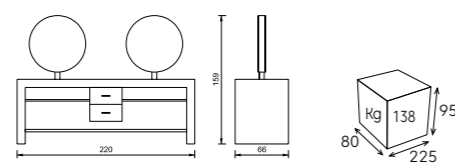

polaris wall - ART. 5182



ART. 5182 - Modulo 2 posti lavoro, struttura in laminato plastico, poggiapiedi in acciaio.
 Styling units 2 working, structure in plastic laminated, footrest in steel.
 Coiffeuse à 2 places, structure en stratifié, repose pieds en acier.

ART. 5182

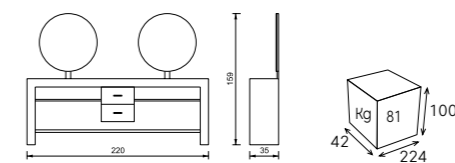

giotto - ART. 8246



ART. 8246 - Centrale bifacciale, base in cemento fuso, struttura in laminato bianco e supporto specchio in metallo verniciato bianco.
Free standing double styling unit, basement in cement, structure in white laminate and mirror support in white painted metal.
Centrale double face, base en beton, structure en stratifié blanc, support miroir en metal verni blanc.

ART. 8246

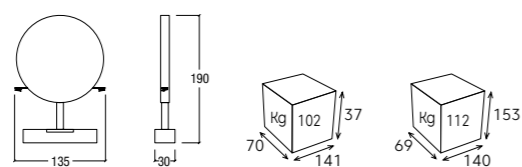

giotto+ - ART. 8247

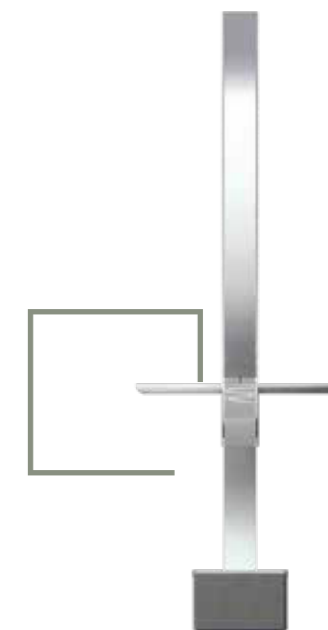

ART. 8247 - Centrale bifacciale, base in cemento fuso, struttura in laminato bianco e supporto specchio in metallo verniciato bianco. Piano lavoro in legno laccato.
Free standing double styling unit, basement in cement, structure in white laminate and mirror support in white painted metal. Top in laquered wood.
Centrale double face, base en beton, structure en stratifié blanc, support miroir en metal verni blanc. Tablette en bois laqué.

ART. 8247

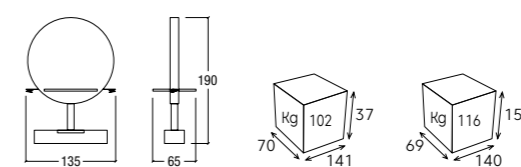



natural light

natural light - ART. 9321



ART. 9321 - Struttura in laminato plastico, base in cemento fuso, lampada decorativa incorporata.
 Structure in plastic laminated, base en cement, decorative lamps included.
 Structure en stratifié, base en beton, lampe decorative incorporée.

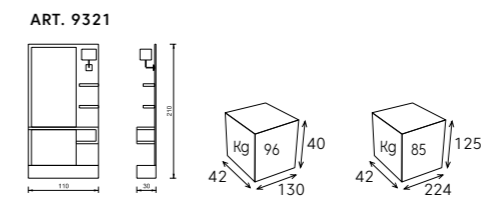

natural double - ART. 9324



ART. 9324 - Base in cemento fuso.
Basement in cement.
Base en beton.

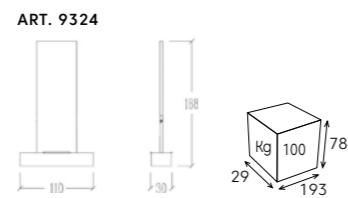

natural double

natural+ - ART. 9326



ART. 9326 - Mobiletto laterale in laminato plastico, base in cemento.
Lateral structure in laminated, base in cement.
Structure lateral en stratifié, base en beton.

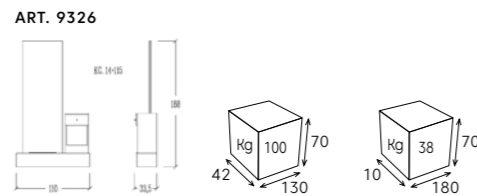

baroque - ART. 9325



ART. 9325 - Cornice in legno agglomerato colore alluminio, piano lavoro in legno laccato e vetro retroilluminato da led, poggiatesta laccato e acciaio.

Frame in agglomerate wood with decorative led lighting, silver color, top in laquered wood and glass with led lighting, footrest in cement and steel.

Cadre en bois agglomeré couleur aluminium, top en bois laqué et verre rétro-éclairé à led, repose pieds laqué et en acier.

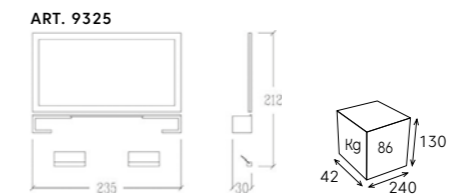





queen

queen - ART. 4009 - queen light - ART. 4009/B



ART. 4009/B

ART. 4009 - Cornice in agglomerato colore argento, piano lavoro in vetro fumè poggiatesta in acciaio cromato.

Frame in agglomerate, silver color, top in glass, footrest in chromium plated metal.

Cadre en agglomerè couleur argent, tablette en verre fumè, repose pieds en acier chromè.

ART. 4009/B con illuminazione - with light - avec éclairage

Cornice in agglomerato colore argento, piano lavoro in vetro fumè, poggiatesta in acciaio cromato, illuminazione decorativa a led incorporata.

Frame in agglomerate with decorative led lighting, silver color, footrest in chromium plated metal.

Cadre en agglomerè couleur argent, tablette en verre fumè, repose pieds en acier chromè, éclairage à led incorporée.

ART. 4009 - 4009/B



queen plus - ART. 4010



ART. 4010 - Cornice in agglomerato colore argento, piano lavoro in laminato nero lucido poggiapiede in acciaio cromato, illuminazione decorativa a led incorporata.

Frame in agglomerate with decorative led lighting, silver color, top in black laminated, footrest in chromium plated metal.

Cadre en agglomerè couleur argent, tablette en startifié noir brillant, repose pieds en acier chromé, éclairage à led incorporé

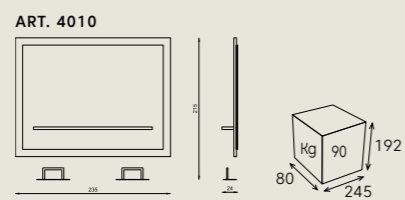

queen plus



flavia

flavia - ART. 8242/16



ART. 8242/16 - Struttura in nobilitato nei colori indicati, piano di lavoro in alluminio con foro porta phon, poggiatesta non incluso.

Frame in pre-laminated in the indicated colours, top in aluminium with arrangement for dryer holder, foot rest not included.

Structure en mélaminé dans les couleurs indiqués, plan de travail en aluminium avec trou porte sechoir, repose pieds pas inclus.

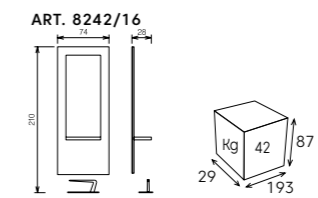

passion glass - ART. 4008 - passion glass light - ART. 4007



ART. 4008 - Specchio con contorni acidati, senza illuminazione, piano lavoro in laminato bianco, poggiatesta in metallo cromato.
Mirror with etched outlines, without lighting, top in white laminated, footrest in chromium plated metal.
Miroir avec contours acides, sans éclairage, tablette en stratifié blanc. Repose pieds en metal chromé.

ART. 4007 con illuminazione - with light - avec éclairage

Specchio con contorni acidati, illuminazione incorporata, piano lavoro in laminato bianco, poggiatesta in metallo cromato.
Mirror with etched outlines, lighting incorporated, top in white laminated, footrest in chromium plated metal.
Miroir avec contours acides, éclairage incorporée, tablette en stratifié blanc. Repose pieds en metal chromé.

ART. 4008 - 4007

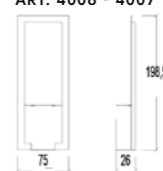

ART. 4008
PASSION GLASS

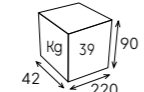

ART. 4007
PASSION GLASS LIGHT

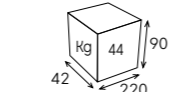

passion glass light



sophia - ART. 4023



ART. 4023 - Struttura e piedi in legno laccato, cornice specchiera in legno agglomerato colore alluminio.

Frame and feet in laquered wood, cornice in agglomerate wood silver color.

Structure et pieds en bois laqué, cadre en bois aggloméré couleur alluminim.

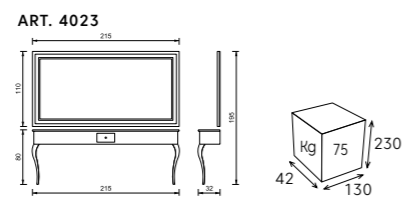

sophia one - ART. 4021



ART. 4021 - Struttura e piedi in legno laccato, cornice specchiera in legno agglomerato colore alluminio.

Frame and feet in laquered wood, cornice in agglomerate wood silver color.

Structure et pieds en bois laqué, cadre en bois aggloméré couleur alluminim.

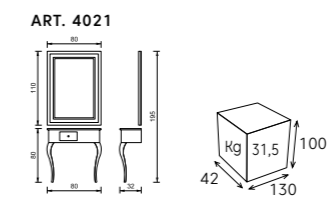

sophia wall - ART. 4022



ART. 4022 - Struttura e piedi in legno laccato, cornice specchiera in legno agglomerato colore alluminio.

Frame and feet in laquered wood, cornice in agglomerate wood silver color.

Structure et pieds en bois laqué, cadre en bois aggloméré couleur alluminim.

ART. 4022

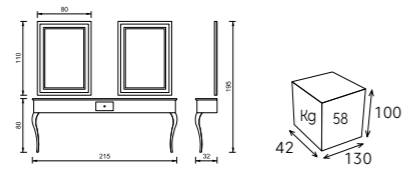

marilyn island - ART. 4030



ART. 4030 - Struttura, piedi e supporto specchi in legno laccato.

Frame, feet and mirror support in laquered wood.

Structure, pieds et support miroirs en bois laqué.

ART. 4030

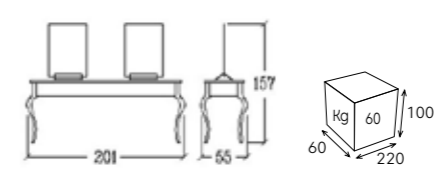



make up

make up - ART. 4038



ART. 4038 - Struttura in laminato, faretto serie egoluce incorporati.
 Coffe in laminated, lighting included.
 Caisson en laminé, spots serie egoluce incorporée.

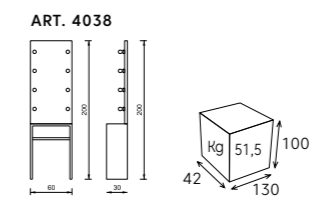

komodo - ART. 4165



ART. 4165 - Tavolo lavoro 4 posti, struttura in laminato plastico, poggiapiedi in acciaio.
Table 4 places, frame in plastic laminated, foot-rest in steel.
Table 4 places, structure en stratifié, repose-pieds en acier.

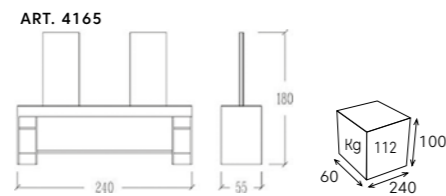

liberty - ART. 8268



ART. 8268 - Modulo 2 posti lavoro, base in nobilitato nei colori indicati, poggiapiedi in acciaio, lampada inclusa. Pannello in nobilitato bianco.
Styling unit 2 places, frame in pre-laminated in the colours indicated, foot rest in steel, decorative lamp included. Back panel in white pre-laminated.
Coiffeuse à 2 places, structure en mélaminé dans les couleurs indiquées, repose pieds en métal, lampe décorative incorporée. Panneau en mélaminé blanc.

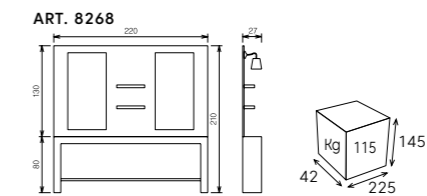

bianco	nero	bardolino	rovere	tartufo

Nobilitato per struttura.
Pre-laminated for frame.
Mélaminé pour structure.

movie - ART. 8241/16



ART. 8241/16 - Struttura in nobilitato nei colori indicati, piano lavoro in laminato bianco o nero, poggiapiedi non incluso.

Frame in pre-laminated in the colours indicated, top in white or black laminated, foot rest not included.

Structure en mélaminé dans les couleurs indiquées, tablette en stratifié blanc ou noir, repose pieds pas inclus.

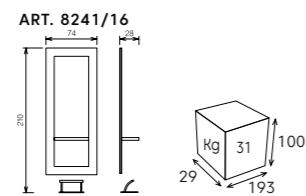

movie

supernova - ART. 8269



supernova



ART. 8269 - Modulo 2 posti lavoro, struttura in nobilitato nei colori indicati, piano lavoro in laminato bianco o nero, poggiatesta in tubolare.

Styling unit 2 places, frame in pre-laminated in the colours indicated, top in white or black laminated, foot rest in steel.

Coiffesue à 2 places, structure en mélaminé dans les couleurs indiquées, tablette en mélaminé blanc ou noir, repose pieds en métal.

bianco lucido nero lucido
Colori per piano lavoro.
Colors for shelf.
Couleurs pour tablette.

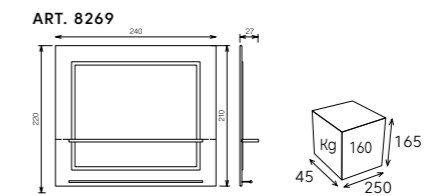



bianco nero bardolino rovere tartufo

Nobilitato per struttura.
Pre-laminated for frame.
Mélaminé pour structure.

watch - ART. 9328

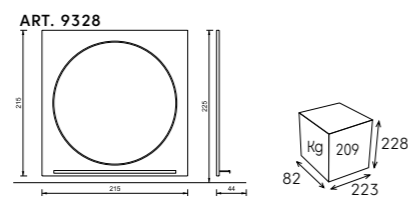

ART. 9328 - Struttura in laminato plastico, cornice alluminio e poggiatesta in acciaio inox.
Structure in plastic laminated, frame in aluminium and foot rest in stainless steel.
Structure en stratifié, cadre en aluminium et repose-pied en acier inox.



watch

clash 1 - ART. 8233



ART. 8233 - Modulo per un posto lavoro, struttura in nobilitato nei colori indicati.
 Module for one styling units, frame in pre-laminated in the colours indicated.
 Module pour un place de travail. Structure en mèlaminé dans les couleurs indiquées.

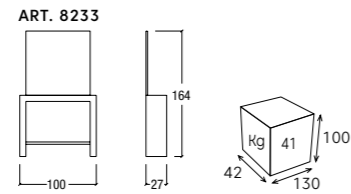

clash - ART. 8230



ART. 8230 - Modulo per due posti lavoro, struttura in nobilitato nei colori indicati.
 Module for two styling units, frame in pre-laminated in the colours indicated.
 Module pour deux places de travail. Structure en mèlaminé dans les couleurs indiquées.

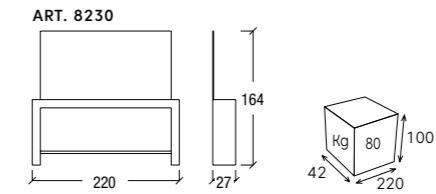

ikon - ART. 8245



ART. 8245 - Tavolo lavoro 4 posti, gambe in vetro temprato.
Poggiapiedi in acciaio.
Table 4 places, top in plastic laminated, legs in temperate glass.
Footrest in steel.
Table 4 places, plan de travail en stratifié, jambes en verre temperé.
Repose pieds en acier.

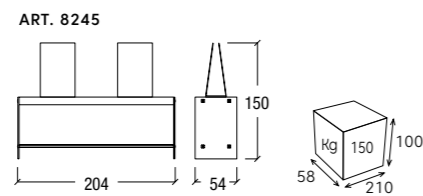

curve postazione barbiere - ART. 9840



ART. 9840 - Struttura laminato plastico colore a scelta, supporto decorativo in materiale poliuretano bianco, specchiera, lavello e gruppo idraulico compresi.
Frame in plastic laminated color at choice, decorative support in white polyurethane material, looking glass, hydraulic pipes included.
Structure en stratifié couleur à choix, glace, support decorative en matériel poliurethane blanc, robinetterie incorporée.

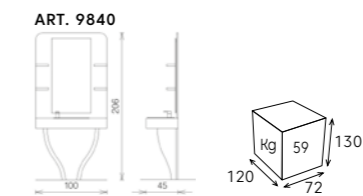

jazz - ART. 4191L / 4191R



jazz
ART. 4191R

meteor+
ART. 4190P

jazz
ART. 4191L



meteor+ - ART. 4190P

Struttura in laminato plastico, lavello in ceramica, rubinetteria incorporata.

Frame in plastic laminated, pottery basin, tap incorporated.

Structure en stratifié, bassin en ceramique, robinetterie incorporee.

ART. 4191L / 4191R - Struttura in laminato plastico.
Frame in plastic laminated.
Structure en stratifié.

ART. 4191L / 4191R

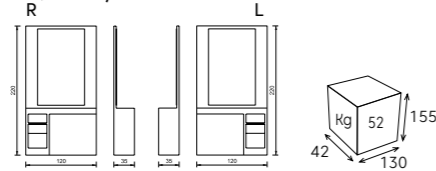

ART. 4190P

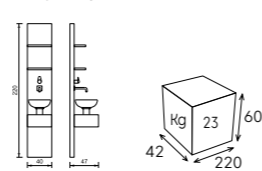

goya - ART. 8272



ART. 8272 - Banco barbiere postazione singola, struttura in laminato, lavello, gruppo idraulico e lampade decorative incorporati.

Single Barber Unit frame in plastic laminated, basin, hydraulic pipes and decorative lamps included.

Place de travail barbiere individuel, structure en stratifié, evier, robinetterie et lampes decoratives incorporee.

ART. 8272

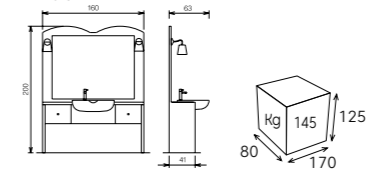



retrò 2.0 - ART. 5052



ART. 5052 - Banco a 2 postazioni lavoro, struttura in laminato plastico con finiture in legno naturale, lavello gruppo idraulico e lampade decorative incorporati.

Unit with 2 working places, structure in plastic laminated with decoration in natural wood. Basin, hydraulic pipes and decorative lamps included.

Duoble places de travail individuel, structure en stratifié, decoratios en bois naturel evier robinetterie et lampes decoratives incorporée.

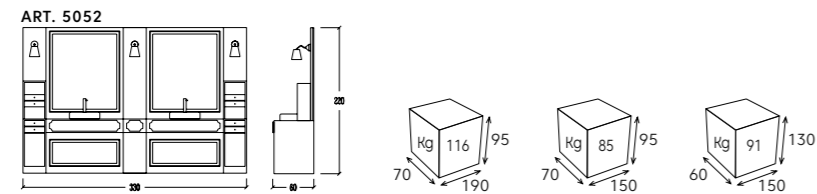

retrò - ART. 5051



ART. 5051 - Banco a postazione singola, struttura in laminato plastico con finiture in legno naturale, lavello gruppo idraulico e lampade decorative incorporati.

Single barber unit, structure in plastic laminated with decoration in natural wood. Basin, hydraulic pipes and decorative lamps included.

Place de travail individuel, structure en stratifié, decoratios en bois naturel, evier robinetterie et lampes decoratives incorporée.

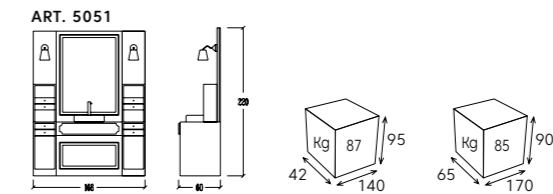



04

tavoli cassa
cash register table
tables caisse

 **VEZZOSI**

industrial desk - ART. 6840



ART. 6840 - Struttura in laminato effetto legno noce pacifico tabacco, supporto piano in ferro verniciato nero opaco, piano in laminato nero opaco.

Frame in wood effect laminate noce pacifico tabacco, top support in mat black painted steel, top in black mat laminated.

Structure en stratifié plastique effect bois noce pacifico tabacco, support par le top en acier peint couleur noir mat, top en stratifié noir mat.



ART. 6840

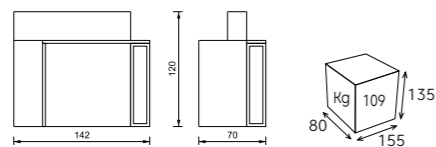



fancy cassa - ART. 6830



ART. 6830 - Struttura in laminato plastico, pianetto porta borsa in gres porcellanato, color onice, su supporto in laminato plastico sorretto da telai metallici verniciati color oro.

Structure in plastic laminate, bag shelf in porcelain stoneware, onyx color, on plastic laminate support supported by metal frames painted in gold color.

Structure en stratifié plastique, étagère sac en grès cérame, couleur onyx, sur support en stratifié plastique soutenu par des cadres métalliques peints en couleur or.

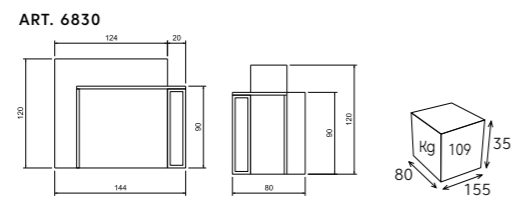

flora cassa - ART. 6835



ART. 6835 - Basamento e telaio reggi piano in acciaio verniciato color oro, struttura in laminato plastico.

Base and top support frame in gold painted steel, structure in plastic laminate.

Base et cadre de support supérieur en acier peint en or, structure en stratifié plastique.

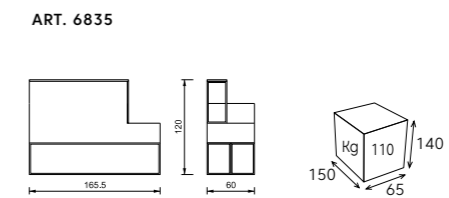

iron cassa - ART. 6825



ART. 6825 - Cassa Iron, la luce mette in risalto la perfezione imperfetta della rete metallica grezza.
Iron reception, the light highlights the imperfect perfection of the raw metal net.
Caisse Iron, l'éclairage met en évidence la perfection imparfaite du filet en metal brut.



ART. 6825

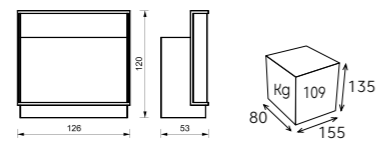



love

love - ART. 6755



ART. 6755 - Struttura in laminato colorpact campionario ABET, illuminazione a led incorporata.

Structure in laminated colorpact ABET sample, led lighting included.

Structure en stratifié colorpact sample ABET, led illumination incorporée.

ART. 6755

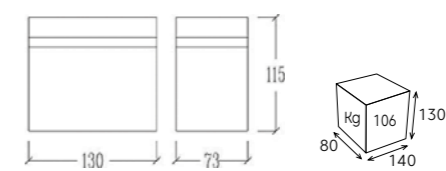

natural desk - ART. 6190

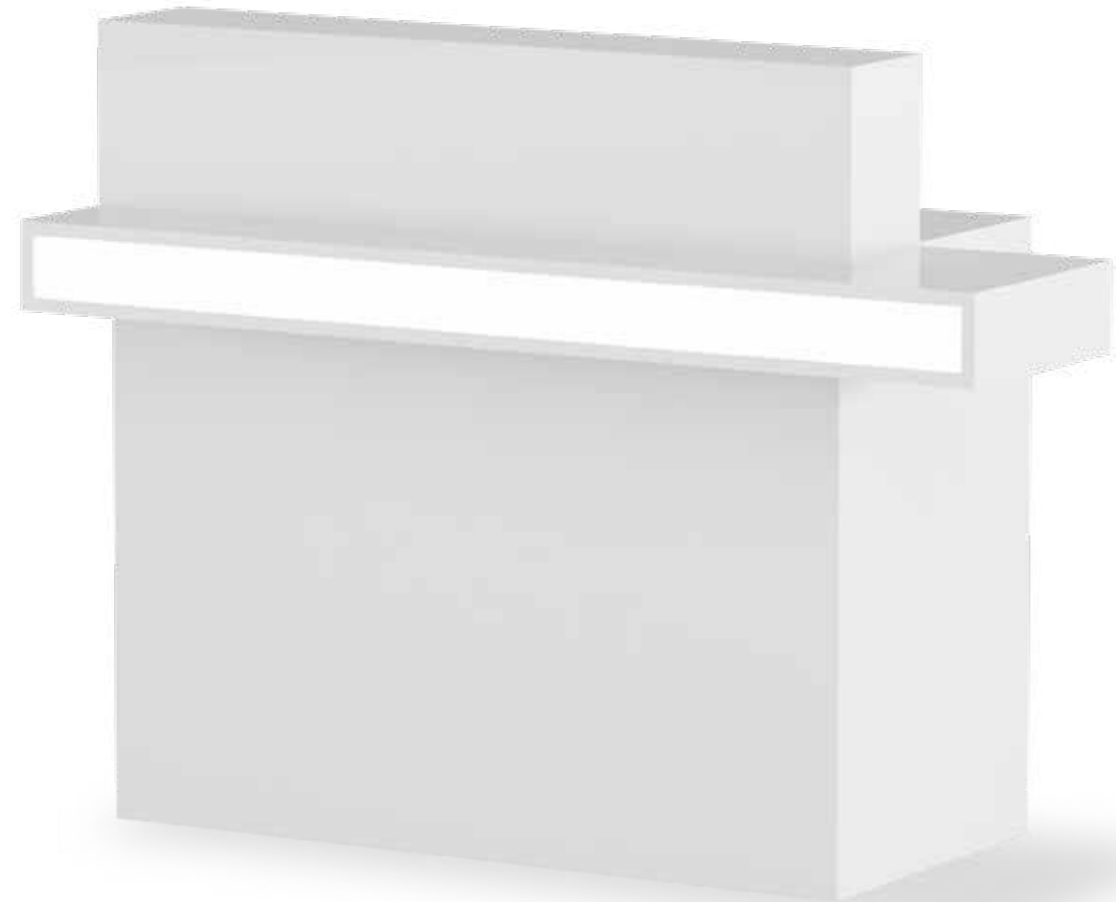

ART. 6190 - Struttura in laminato plastico, illuminazione a led incorporata.

Structure in plastic laminated, led lighting included.

Structure en stratifié, illumination incorporée.



ART. 6190

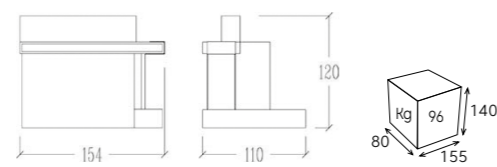

corner desk - ART. 6756



ART. 6756 - Struttura in laminato plastico con illuminazione incorporata.

Frame in plastic laminated with lighting incorporated.

Structure en stratifié avec illumination incorporée.



ART. 6756

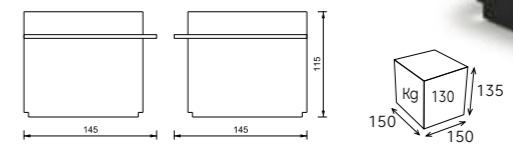

LUZ - ART. 6758



ART. 6758 - Struttura in laminato plastico,
frontale con illuminazione ricoperto in skai.

Structure in plastic laminated,
frontal covered in skai with lighting.

Structure en stratifié,
frontal recouvert en skai avec éclairage.

ART. 6758

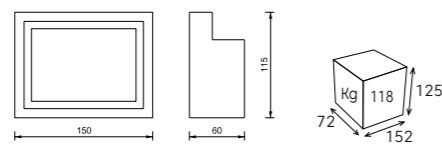

smile - ART. 8416



ART. 8416 - Struttura in nobilitato bianco, frontale in nobilitato nei colori indicati illuminazione frontale con striscia a led.
 Frame in white plastic laminated, frontal in plastic laminated in the indicated colors, frontal lighting with strip of led.
 Structure en stratifié blanc, facade en stratifié dans les couleurs indiquées, éclairage frontale avec bande de led.

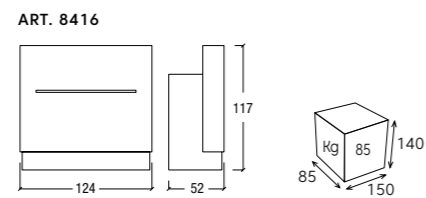

marilyn desk - ART. 6030



ART. 6030 - Struttura e piedi in legno laccato.
 Frame and feet in laquered wood.
 Structure et pieds en bois laqué.

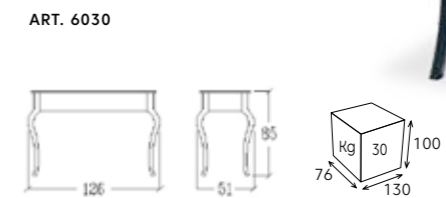

audrey - ART. 8417



audrey



ART. 8417 - Struttura in nobilitato bianco, frontale in nobilitato nei colori indicati.

Frame in white plastic laminated, frontal in plastic laminated in the indicated colors.

Structure en stratifié blanc, facade en stratifié dans les couleurs indiquées.



ART. 8417

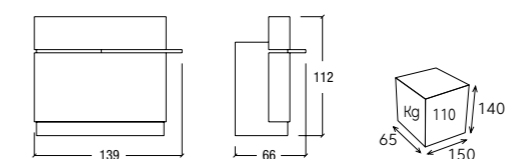

amelie - ART. 8426

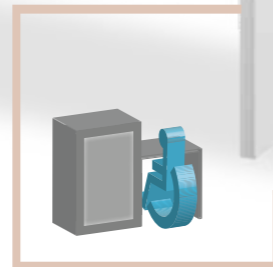

ART. 8426 - Struttura e consolle in nobilitato bianco, frontale in nobilitato nei colori indicati, illuminazione incorporata.
Frame and console in white plastic laminated, frontal in plastic laminated in the indicated colors, lighting incorporated.
Structure en stratifié blanc, façade et consolle en stratifié dans les couleurs indiquées, illumination incorporée

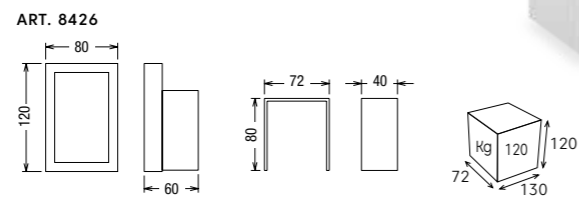

amelie

dorian - ART. 8425



dorian



ART. 8425 - Struttura in nobilitato bianco, frontale in nobilitato nei colori indicati. Illuminazione incorporata.

frontal in plastic laminated in the indicated colors. Lighting incorporated.

Structure en stratifié blanc, façade en stratifié dans les couleurs indiquées. Illumination incorporée



ART. 8425

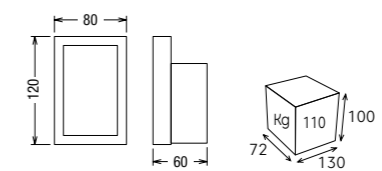

colour desk - ART. 6300



ART. 6300 - Specchi basculanti, struttura in laminato plastico, illuminazione incorporata.

Tilting mirrors, frame in plastic laminated, led lighting included.

Miroirs basculantes, structure en stratifié, led illumination incorporée.

ART. 6300

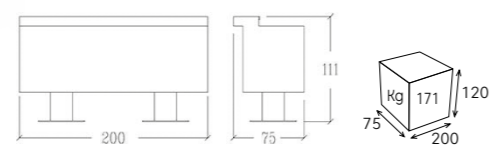

j-lo desk - ART. 8415



ART. 8415 - Struttura in nobilitato bianco, frontale in skai con finitura capitonné.

Frame in white plastic laminated, frontal in skai capitonné.

Structure en stratifié blanc, frontal en skai capitonné.

ART. 8415

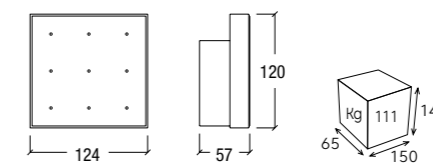

spice - ART. 8410



ART. 8410 - Struttura posteriore in nobilitato bianco. Frontale in nobilitato nei colori indicati. Illuminazione incorporata.

Frame in white plastic laminated. Frontal in plastic laminated in the indicated colors. Lighting included.

Structure en stratifié blanc. Façade en stratifié dans les couleurs indiquées. Eclairage incorporé.

ART. 8410

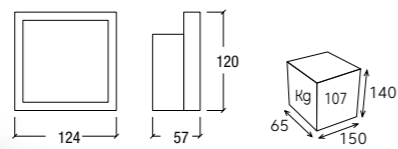

welcome - ART. 8428



welcome

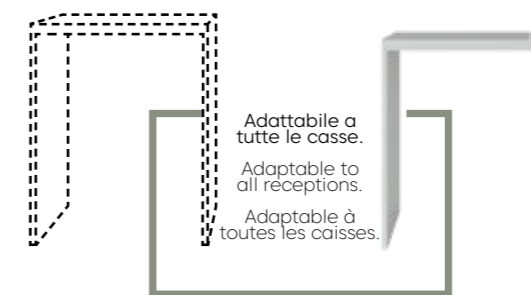
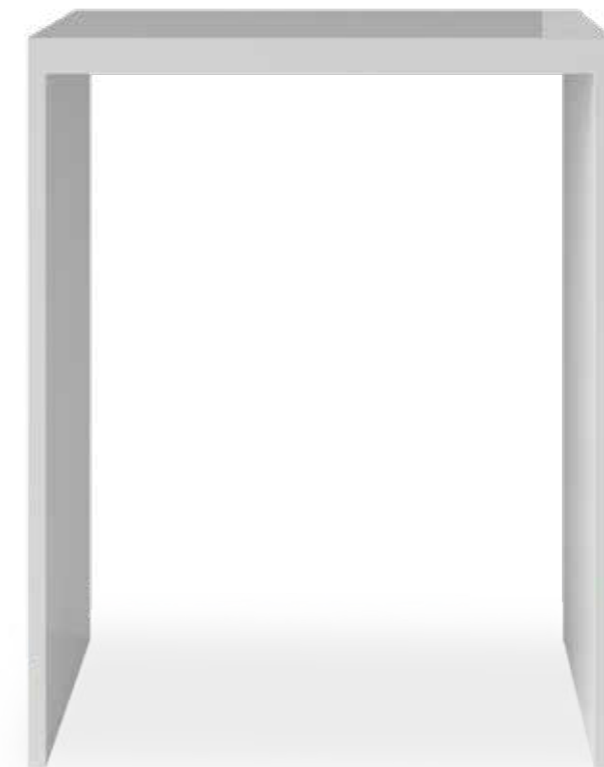

ART. 8428 - Struttura in nobilitato bianco.
Frame in white plastic laminated.
Structure en stratifié blanc.

Nobilitato per struttura.
Pre-laminated for frame.
Mélaminé pour structure.

-  bianco
-  nero
-  bardolino
-  rovere
-  tartufo

ART. 8428

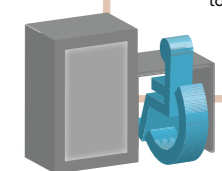
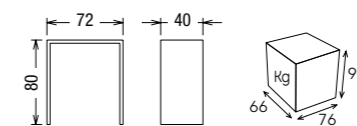



05

poltrone attesa
waiting chairs
fauteuils attente

 **VEZZOSI**

posh waiting - ART. 2070



ART. 2070 - Rivestimento in skai, zoccolo in laminato oro.
Upholstery in skai, plinth in gold laminate
Rembourrage en skai, soclè en stratifié or.

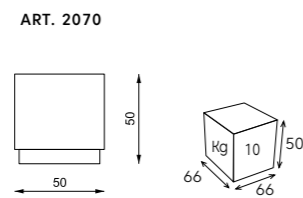

flora waiting - ART. 2075



ART. 2075 - Telaio in acciaio verniciato oro, tappezzeria in skai.
Frame in gold painted steel, upholstery in skai.
Structure en acier verni or, tapisserie en skai.

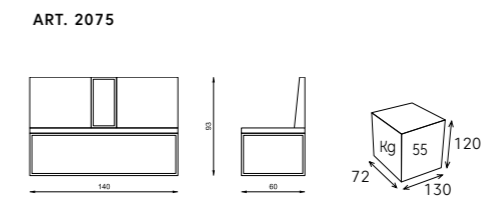

lolita - ART. 2245



ART. 2245 - Struttura in laminato plastico, tappezzeria in skai.
Structure in plastic laminated, upholstery in skai.
Structure en stratifié, Tapisserie en skai.

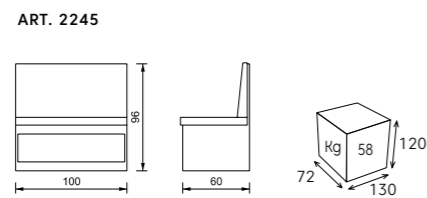

il rettangolo - ART. 2900 - il bacello - ART. 2950 - quadrotto - ART. 2800



ART. 2800



ART. 2900



ART. 2950

ART. 2900 - ART. 2950 - Puff 2 posti, piedi in alluminio, tappezzeria in skai.
Pouf 2 places, feet in aluminium, upholstery in skai.
Pouf 2 places, pieds en aluminium, tapisserie en skai.

ART. 2800 - Puff, piedi in alluminio, tappezzeria in skai.
Pouf, feet in aluminium, upholstery in skai.
Pouf, pieds en aluminium, tapisserie en skai.

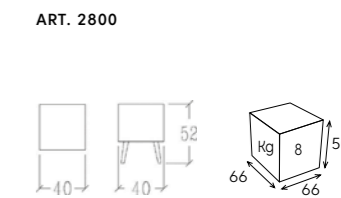
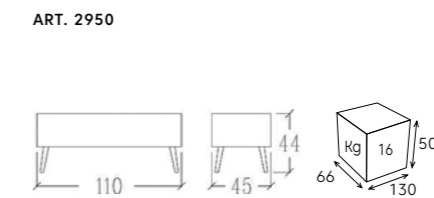
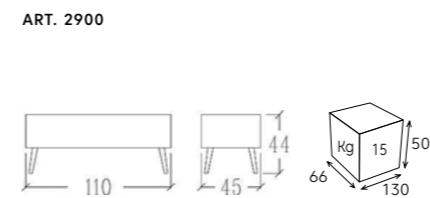

fusion - ART. 5800



fusion



ART. 5800 - Struttura completamente rivestita in skai.
Structure completely upholstered in skai.
Structure completement couverte en skai.

ART. 5800

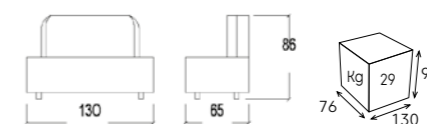

ginevra - ART. 2280 - portacasco - ART. 2281



ART. 2280 - ART. 2281 portacasco - dryer-holder - porte casque
Struttura completamente rivestita in skai.
Structure completly upholstered in skai.
Structure completement couverte en skai.

ART. 2280



ART. 2281

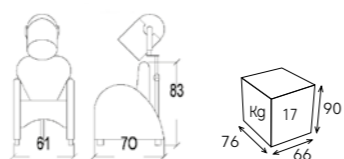

ginevra sofà - ART. 2282 - portacasco - ART. 2283



ART. 2282 - ART. 2283 portacasco - dryer-holder - porte casque
Struttura completamente rivestita in skai.
Structure completly upholstered in skai.
Structure completement couverte en skai.

ART. 2282

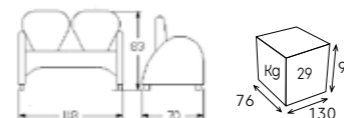

ART. 2283

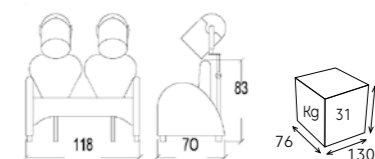

star - ART. 2130



ART. 2130 - Sostegno schienale in metallo verniciato, piedi in alluminio, tappezzeria in skai.
 Back holder in painted metal, feet in aluminium, upholstery in skai.
 Support du dossier en metal verni, pieds en aluminium, tapisserie en skai.

ART. 2130

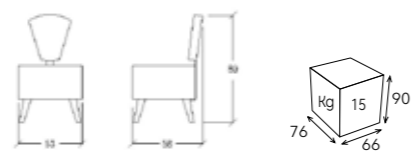

star 3 - ART. 2135



ART. 2135 - Sostegno schienale in metallo verniciato, piedi in alluminio, tappezzeria in skai.
 Back holder in painted metal, feet in aluminium, upholstery in skai.
 Support du dossier en metal verni, pieds en aluminium, tapisserie en skai.

ART. 2130



royal waiting - ART. 8320 - portacasco - ART. 8321



ART. 8320 - ART. 8321 portacasco - dryer-holder - porte casque

Struttura imbottita e completamente rivestita in skai, colore tappezzeria a scelta.

Structure completely covered in skai at choice.

Structure completement couverte en skai à choix.

ART. 8320

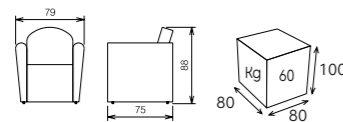

ART. 8321

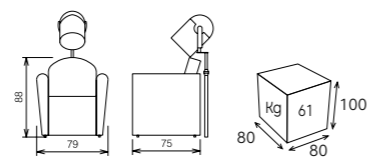

royal sofà - ART. 8325 - portacasco - ART. 8326



ART. 8325 - ART. 8326 portacasco - dryer-holder - porte casque

Struttura imbottita e completamente rivestita in skai, colore tappezzeria a scelta.

Structure completely covered in skai at choice.

Structure completement couverte en skai à choix.

ART. 8325

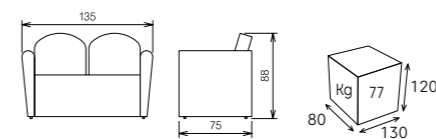

ART. 8326

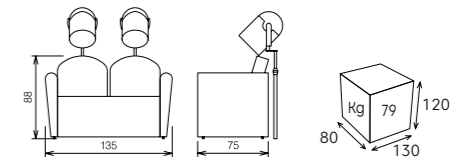



06

mobili expo
expo furnishing
meubles expo

 **VEZZOSI**



flora

flora expo - ART. 9377



ART. 9377 - Basamento, telai verticali reggipiano verniciati color oro.
Ripiani, struttura e cassetti in laminato plastico.

Base, vertical shelf support frames in gold painted steel.
Shelves, structure and drawers in plastic laminate.

Base, cadres de support d'étagères verticales en acier peint or.
Étagères, structure et tiroirs en stratifié plastique.

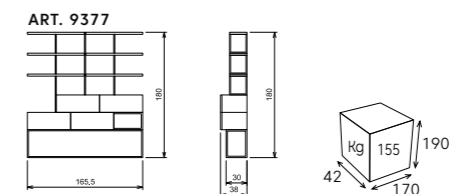

natural expo - ART. 506



ART. 506 - Struttura e piani in laminato plastico con illuminazione incorporata, base in cemento.

Structure and shelves in plastic laminated with light inside, base in cement.

Structure et tablettes en stratifié a vec illumination incorporée, base en beton.

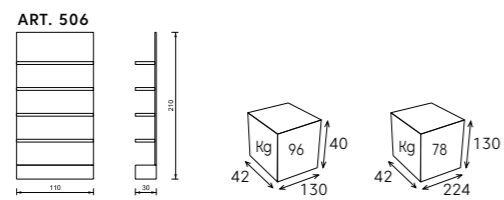

xilema expo - ART. 510



ART. 510 - Struttura in laminato plastico, piani in vetro, angoli acciaio.
 Frame in plastic laminated wood, tops in glass, angulares in steel.
 Structure en stratifié, tablettes en verre, angulaires en acier.

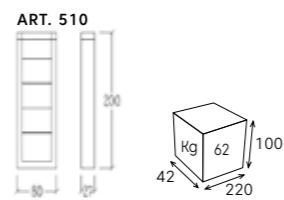

expo new - ART. 8601/16



ART. 8601/16 - Struttura in nobilitato nei colori indicati, piani in vetro.
 Frame in pre-laminated in the indicated colours, shelves in glass.
 Structure en mélaminé dans les couleurs indiquées, tablettes en verre.

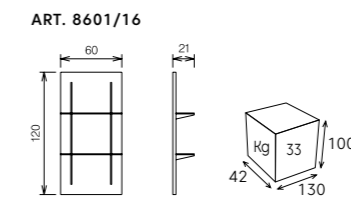

Nobilitato per struttura.
 Pre-laminated for frame.
 Mélaminé pour structure.



bianco lucido



478 grey



07

mobili servizio
salon furnishing
meubles de rangement

 **VEZZOSI**

iron expo - ART. 9376



ART. 9376 - Essenziale, funzionale e urban, il mobile expo della collezione Iron è un arredo indispensabile, in quanto funge da pratico espositore. Dotato di ampi sportelli, la rete metallica effetto industriale rende questo completamente perfetto nella sua apparente imperfezione.

Essential, functional and urban, the expo cabinet from the Iron collection is an indispensable piece of furniture, as it acts as a practical display unit. Equipped with large doors, the industrial effect wire mesh makes this completely perfect in its apparent imperfection.

Essentiel, fonctionnel et urbain, le meuble expo de la collection Iron est indispensable, car il est un présentoir pratique. Doté de grandes portes, le grillage à effet industriel rend ce meuble tout à fait parfait dans son apparente imperfection.

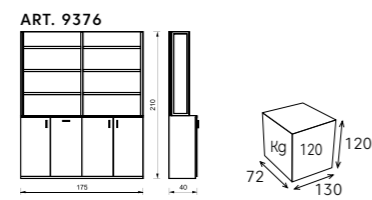

colour service - ART. 6305



ART. 6305 - Struttura e sportelli in laminato plastico.
Frame and doors in plastic laminated.
Structure et portieres en stratifié.

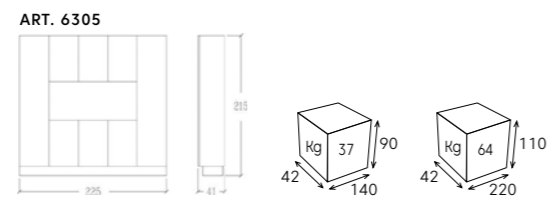

wood - ART. 9360/B - 9360



ART. 9360/B - 9360 - Struttura in nobilitato color bianco con tubolari in acciaio retroilluminati a led, cassettei visual e sportelli in laminato plastico colore a scelta, mensole in vetro. Top unico in laminato a scelta, vedi listino.
Frame in pre-laminated colour white with tubulars in steel lighted with led, drawers visual and doors in plastic laminated colour at choice, shelves in glass. Top in plastic laminated at choice, see pricelist.
Structure en mélaminé couleur blanc avec tubulaires en acier éclairé a led, tiroirs visual et portieres en stratifié couleur au choix, tablettes en verre. Top en stratifié couleur à choix, voir liste de prix.

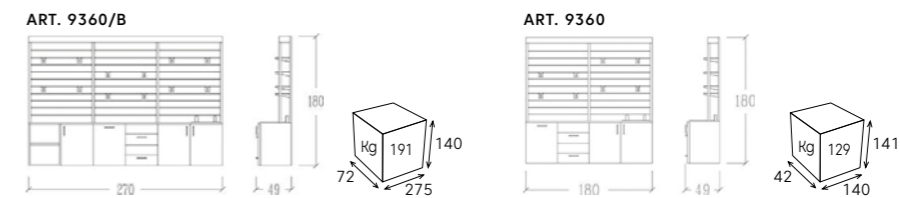

beauty - ART. 9355



beauty



ART. 9355 - Struttura in laminato plastico, lavello inox, gruppo idraulico ed illuminazione a led incorporata.

Structure in plastic laminated, inox basin, hydraulic pipe and lighting included.

Structure en stratifié, inox basin et éclairage incorporée.

ART. 9355

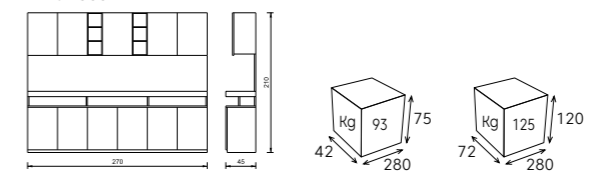

LUXURY - ART. 9350



ART. 9350 - Struttura in laminato all color bianco top e salvamuro in gres porcellanato tipo lamina, lavello inox, gruppo idraulico e illuminazione a faretto incorporata.

Structure in plastic laminated "all color" white, top and wall cover in porcelain gres "3 mm", inox basin, hydraulics pipes, lighting included.

Structure en stratifié all color blanc, top et protection en carrelage gres lamina. Evier complet en inox et éclairage incorporée.

ART. 9350

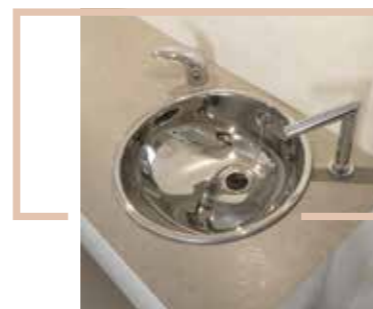
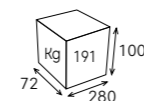
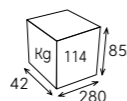
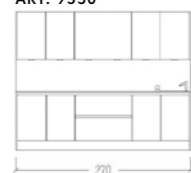

mobili - ART. 707



ART. 707 - Struttura in nobilitato bianco con illuminazione, sportelli in laminato.
 Frame in prelaminated white with led, doors and expo in plastic laminated.
 Structure en laminé blanc brillant avec led, portieres et expo en stratifié.

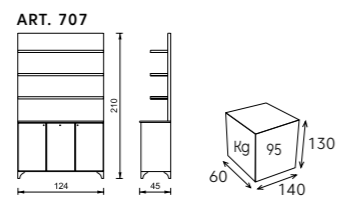

mobili - ART. 706



ART. 706 - Struttura in nobilitato bianco, sportelli in laminato.
 Frame in prelaminated white, doors and expo in plastic laminated.
 Structure en laminé blanc brillant, portieres et expo en stratifié.

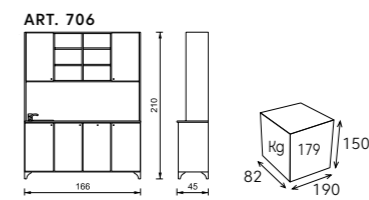

mobili - ART. 705



ART. 705 - Struttura in nobilitato bianco, sportelli in laminato.
Frame in prelaminated white, doors and expo in plastic laminated.
Structure en laminé blanc brillant, portieres et expo en stratifié.

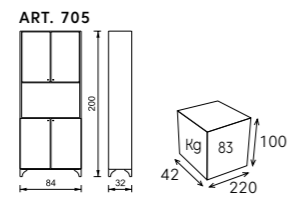

mobili - ART. 702



ART. 702 - Struttura in nobilitato bianco, sportelli in laminato.
Frame in prelaminated white, doors and expo in plastic laminated.
Structure en laminé blanc brillant, portieres et expo en stratifié.

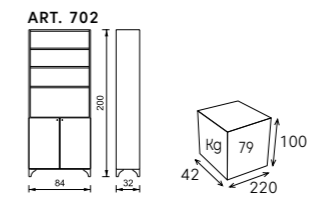

mobili - ART. 8730/16



ART. 8730/16 - Struttura in nobilitato bianco lucido, sportelli in laminato.
Frame in prelaminated color white, doors in laminated.
Structure en mélaminé blanc brillant, portieres en stratifié.

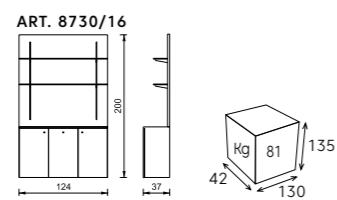

mobili - ART. 8731/16



ART. 8731/16 - Struttura in nobilitato bianco lucido, sportelli in laminato.
Frame in prelaminated color white, doors in laminated.
Structure en mélaminé blanc brillant, portieres en stratifié.

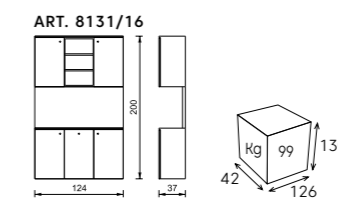

mobili - ART. 8726



ART. 8726 - Struttura in nobilitato bianco lucido, sportelli in laminato.
 Frame in prelaminated color white, doors in laminated.
 Structure en mélaminé blanc brillant, portieres en stratifié.

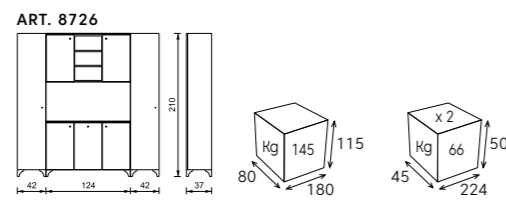

mobili - ART. 8725/16 - 8700/16 - 8720/16

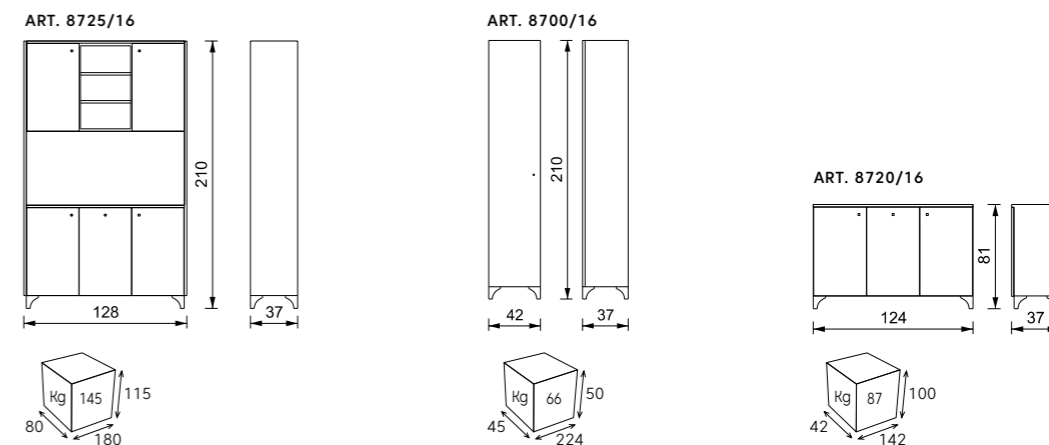

ART. 8725/16 - 8700/16 - 8720/16 - Struttura in nobilitato bianco lucido, sportelli in laminato.
 Frame in prelaminated color white, doors in laminated.
 Structure en mélaminé blanc brillant, portieres en stratifié.





08

complementi
complements
compléments

 **VEZZOSI**

fancy tavolino - ART. 4203



ART. 4203 - Telaio in acciaio verniciato color oro, piano superiore e piano intermedio in laminato plastico.

Frame in gold painted steel, upper and intermediate top in plastic laminate.

Structure en acier verni or, plateau supérieur et intermédiaire en stratifié plastique

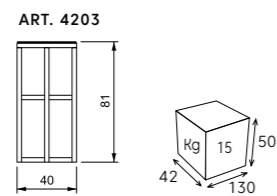

flora tavolino - ART. 4204



ART. 4204 - Telaio in acciaio verniciato color antracite, piano superiore e piano intermedio in laminato plastico con possibilità di rivestimento in skai.

Frame in anthracite painted steel, upper and intermediate top in plastic laminate with the possibility of covering in skai.

Structure en acier peint anthracite, plateau supérieur et intermédiaire en stratifié plastique avec possibilité de revêtement en skai.

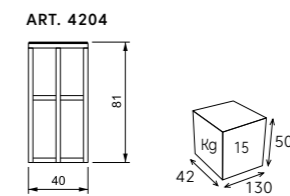

posh closet - ART. 7196



ART. 7196 - Struttura in tubolare verniciato oro.
Tubular structure gold painted.
Structure tubulaire verni or.

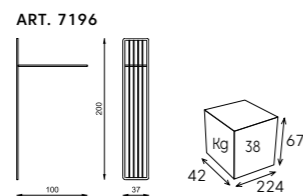

graffio - ART. 7190



ART. 7190 - Appendiabiti, struttura in metallo verniciato con plexiglass inserito.
Wardrobe, frame in painted metal with inside plexiglass.
Vestiaire, structure en metal verni avec dedans plexiglass.

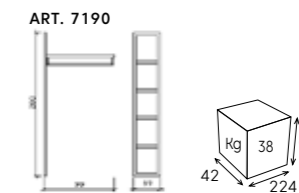

xilema closet - ART. 7195



ART. 7195 - Appendiabiti, struttura in laminato plastico, particolari in acciaio.
Wardrobe frame in plastic laminated, details in steel.
Vestiaire, structure en stratifié, details en acier.

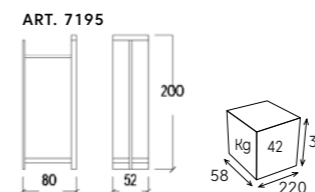

soul - ART. 4225



ART. 4225 - Struttura in laminato plastico.
Frame in plastic laminated.
Structure en stratifié.

ART. 4225

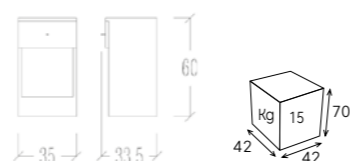

brad - ART. 8251/16



ART. 8251/16 - Struttura in nobilitato nei colori indicati, piedi in metallo lucidato.

Structure in pre-laminated in the indicated colours, feet in shine metal.

Structure en mélaminé dans les couleurs indiquées, pieds en metal ciré.



ART. 8251/16

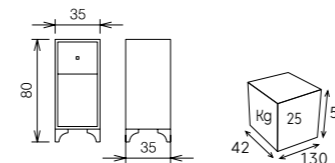

yoik - ART. 4201

ART. 4201 - Struttura in laminato plastico.
Frame in plastic laminated.
Structure en stratifié.



ART. 4201

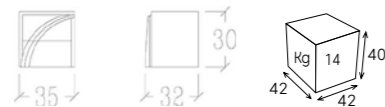

cool - ART. 4215

ART. 4215 - Struttura in laminato plastico.
Frame in plastic laminated.
Structure en stratifié.



ART. 4215

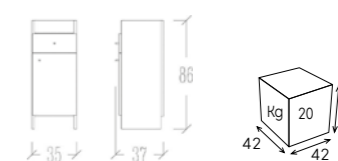

style - ART. 8250

ART. 8250 - Struttura e frontale in nobilitato nei colori indicati.
Frame and frontal in pre-laminated in the indicated colours.
Structure et frontal en mélaminé dans les couleurs indiquées.



ART. 8250

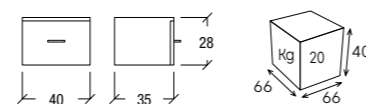

meteor+ - ART. 4190P

ART. 4190P - Struttura in laminato plastico, lavello in ceramica, rubinetteria incorporata.

Frame in plastic laminated, pottery basin, tap incorporated.

Structure en stratifié, bassin en ceramique, robinetterie incorporée.

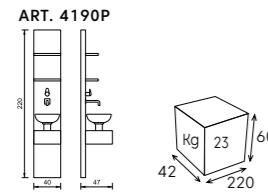

meteor basic - ART. 5075

ART. 5075 - Struttura in laminato plastico, lavello in ceramica, rubinetteria incorporata.

Frame in plastic laminated, pottery basin, tap incorporated.

Structure en stratifié, bassin en ceramique, robinetterie incorporée.

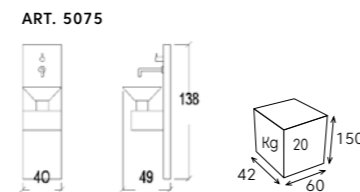

ozzy - ART. 7272

ART. 7272 - Carrello con struttura e frontale cassetti chiuso con finiture antigraffio. Mensola laterale portaphon, ciotola in materiale antiacido. Ruote trasparenti anticapello.

Trolley with structure and drawers frontal closed. Surface anti scratch. Lateral shelf, hairdryer holder, antiacid bowl. Transparent wheels hair proof.

Charriot avec structure et frontal des tiroirs fermés. Surface antirayure. Tablette porte sechoir. Bol antiacide. Roulettes transparents anti cheveu.

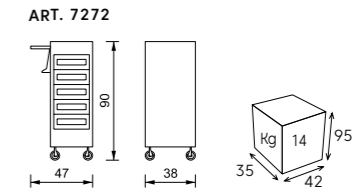

wow - ART. 7270

ART. 7270 - Struttura in laminato plastico.

Frame in plastic laminated.

Structure en stratifié.

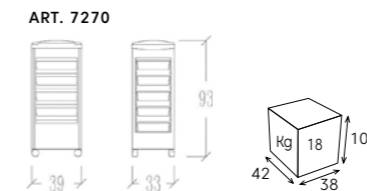

young - ART. 7271

ART. 7271 - Struttura, cassetti, piano superiore e ruote i propilene, piedi in metallo cromato. Cassetti nei colori indicati.

Structure in abs, drawers and wheels in polypropylene, pieds in metal chromé. Drawers in the displayed colors.

Structure en abs, tiroirs and roues en polypropilene, pieds en metal chromé. Tiroirs dans les couleurs presentes.

Colori cassetti.
Drawer colors.
Couleurs des tiroirs.

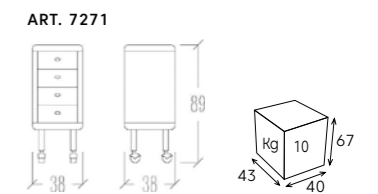

sensor - ART. 7275



ART. 7275 - Sterilizzatore in abs, spegnimento automatico all'apertura dello sportello, lampadina a 9 watt.

Sterilizer in abs, it automatically switches off when the flap is opened, lamp 9 watt.

Sterilisateur en abs, extinction automatique lors que le guichet est ouvert, ampoule 9 watt.

ART. 7275

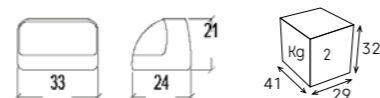

vortice - ART. 7250

ART. 7250 - Portaphon universale in metallo cromato.

Universal dryholder in chromium plated metal.

Porte-sechoir universel en metal chromé.



curve portaphon - ART. 9890



ART. 9890 - Portaphon universale in metallo cromato.

Universal dryholder in chromium plated metal.

Porte-sechoir universel en metal chromé.

bolero - ART. 7143



ART. 7143 - Sgabello, base in alluminio lucidato, sedile in skay.

Stool, shine aluminum base, seat in skay.

Tabouret, base en aluminium brillant, siege en skay.

ART. 7143

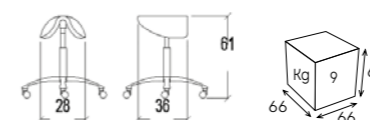

kid - ART. 8252



ART. 8252 - Sgabello, base in alluminio lucidato, seduta in skai.

Stool, shine aluminium base, seat in skai.

Tabouret, base en aluminium brillant, siege en skai.

ART. 8252

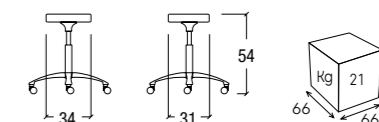

friend - ART. 7290

ART. 7290 - Specchio da tavolo, base in alluminio.
 Mirror for table, base in aluminium.
 Miroir pour table, base en aluminium.

ART. 7290

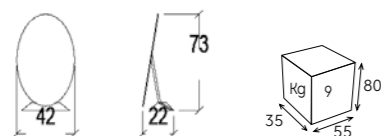

tender double - ART. 7292

ART. 7292 - Specchio doppio da tavolo, base in alluminio.
 Mirror double for table, base in aluminium.
 Miroir double pour table, base en aluminium.

ART. 7292

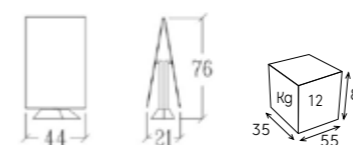

hollywood - ART. 7291

ART. 7291 - Specchio bifacciale, base in legno dorato o a richiesta laccato.
 Two faces mirror, base in gold wood or by request laquered.
 Miroir biphaccial, base en bois doré ou sous demande laqué.

ART. 7291

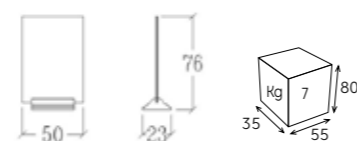

tender - ART. 7293

ART. 7293 - Specchio da tavolo, base in alluminio.
 Mirror for table, base in aluminium.
 Miroir pour table, base en aluminium.

ART. 7293

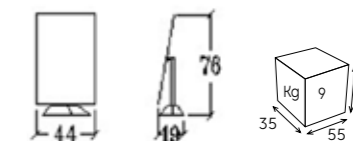



09

estetica
beauty items
esthétique

 **VEZZOSI**

popper - ART. 10015/N



ART. 10015/N - Lettino estetica, legno colore Akumè ad 1 snodo e imbottitura extra. Tappezzeria skai bianco.

Beauty bed in Akumè wood with 1 movement e extra padding. White Upholstery

Lit de massage en couleur bois Akumè avec 1 mouvement e extra mousse. Skai blanc.

ART. 10015/N

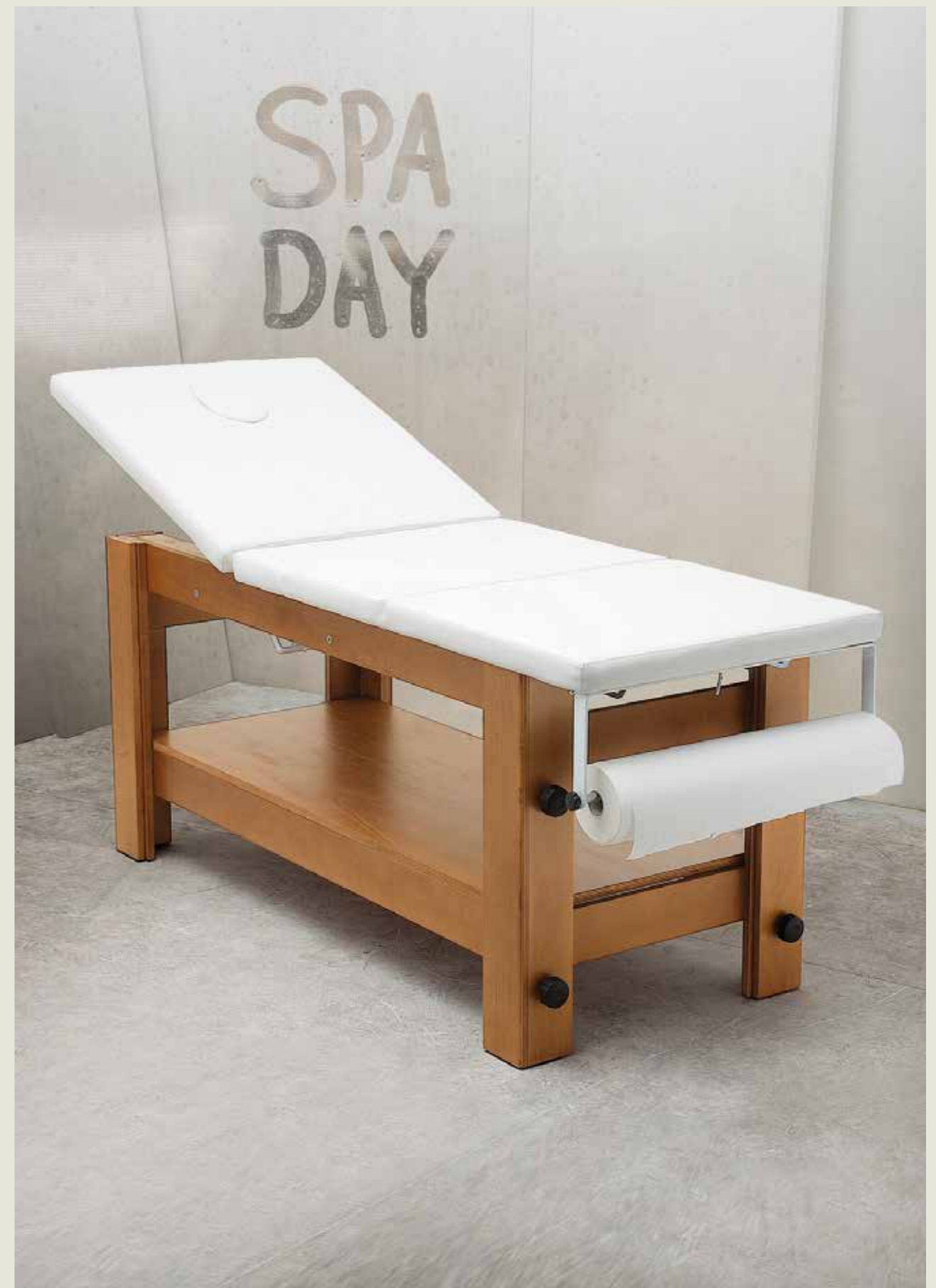
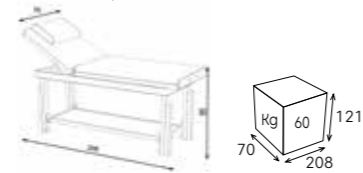

marilyn nails - ART. 10105/N



marilyn nails
ART. 10105/N

expo nails
ART. 10106/N

ART. 10105/N - Struttura in legno laccato, aspiratore e poggiamani incorporati.

Structure in laquered wood, nail dust collector and handrest cushion included.

Structure en bois laqué, aspirateur et coussin appui main inclus.

ART. 10105/N

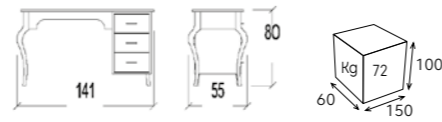

expo nails - ART. 10106/N

ART. 10106/N - Espositore per smalti.

Nail polish expo.
Produits expo.

ART. 10106/N



grace+ - ART. 10065/N



bianco
opaco

Nobilitato per struttura.
Pre-laminated for frame.
Mélaminé pour structure.

ART. 10065/N - Tavolo manicure con espositore per smalti. Ripiani in vetro, struttura in nobilitato bianco opaco, cassettiere, aspiratori e poggiamani incorporati.

Manicure table with nails polish expo. Shelves in glass, frame in pre-laminated in white matt colour, nails dust collector and handrest cushion included.

Table manicure avec exposeur des produit. Etageres en verre, structure mélaminé blanc matt, aspirateur et coussin appui main inclus.

ART. 10065/N

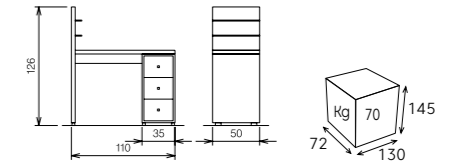

grace double - ART. 10064/N

ART. 10064/N - Doppio tavolo manicure con espositore per smalti al centro. Ripiani in vetro, struttura in nobilitato bianco opaco, cassettiere, aspiratori e poggiamani incorporati.

Double manicure table with double nails polish expo, shelves in glass, frame in pre-laminated in white matt colour, nails dust collector and handrest cushion included.

Double table manicure avec double exposeur des produit, etageres en verre, structure mélaminé blanc matt, aspirateur et coussin appui main inclus.

bianco
opaco

Nobilitato per struttura.
Pre-laminated for frame.
Mélaminé pour structure.



ART. 10064/N

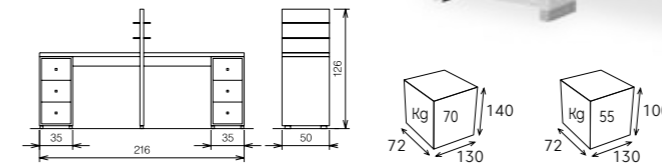



10

poggiapiedi e piedi
foot-rest and feet
repose-pieds et pieds

 **VEZZOSI**

ART. 7340



ART. 7340 - Poggiapiede in acciaio e alluminio lavorato.
Foot-rest in steel and aluminium.
Repose-pieds en acier et aluminium.

ART. 7310



ART. 7310 - Poggiapiede in cemento e acciaio.
Foot-rest in cement and steel.
Repose-pieds en beton et acier.

ART. 7300



ART. 7300 - Poggiapiede in metallo cromato.
Foot-rest in chromium plated metal.
Repose-pieds en metal chromé.

ART. 7300/V



ART. 7300/V - Struttura in metallo verniciato.
Foot-rest in painted metal.
Repose-pieds en metal verni.

ART. 7330



ART. 7330 - Poggiapiede in metallo satinato.
Foot-rest in chromium glazed metal.
Repose-pieds en metal satiné.



poggiapiedi art. 7340

P21



P20



P70



P51



P06

verniciato - painted - verni.



P07

verniciato - painted - verni.



P31

verniciato - painted - verni.



P30

verniciato - painted - verni.



P81



P80



P98



P99



P05



P15

verniciato - painted - verni.



P90



P95





11

caschi
hairdryer
sechoir

 **VEZZOSI**

ginko - ART. 1110 - muro - ART. 1120 - testata - ART. 1100

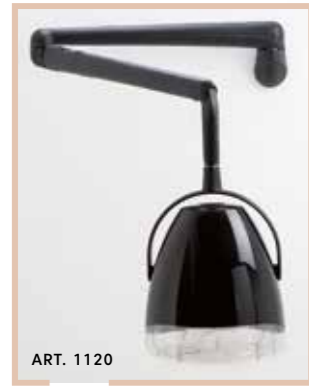

ART. 1110

ART. 1110 - 1120 - 1100 - Casco asciugacapelli in abs, con doppio isolamento, interno in nylon, doppia campana fumè, con asciugatura a pressione d'aria, regolazione elettronica della velocità, colori di serie: nero o grigio argento metallizzato.

Hairdryer in abs plastic material, with double insulation, inner in nylon, double hood fumè, with air pressure drying, electronic regulation of speed, standard colour: metal black or silver.

Sechoir en abs materiel plastique, avec double isolation, interieur en nylon, double coiffe fumè, avec sechage à pression d'air, réglage eletronique de la vitesse, couleurs de serie: noir ou gris metallisé.

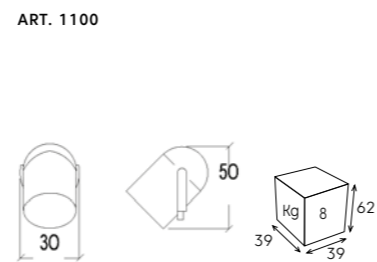
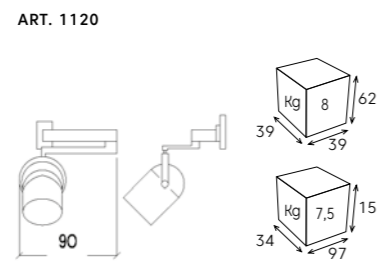
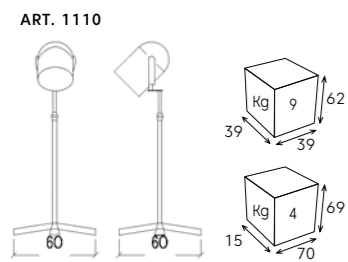

darwin - ART. 1010 - muro - ART. 1020 - testata - ART. 1000



ART. 1010

ART. 1010 - 1020 - 1000 - Casco asciugacapelli con ventilazione diretta, a 2 velocità, costruito in abs, con doppio isolamento, interno in nylon, timer 60', termoregolatore di energia per il calore con resistenza filare, colori di serie: nero o grigio argento metallizzato.

Hairdryer with direct ventilation, 2 speed, built in abs plastic material, with double insulation, inner in nylon, timer 60', thermoregulator of power for the heat with cables resistance, standard colour: metal black or silver.

Sechoir à ventilation directe, au 2 vitesses, en abs materiel plastique, avec double isolation, interieur en nylon, minuterie 60', thermoregulateur de temperature avec resistance à filaments, couleurs de serie: noir ou gris metallisé.

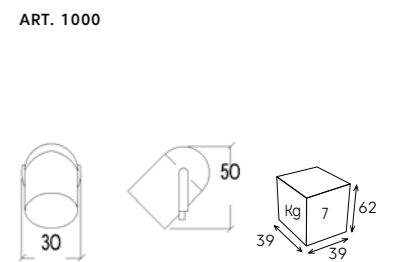
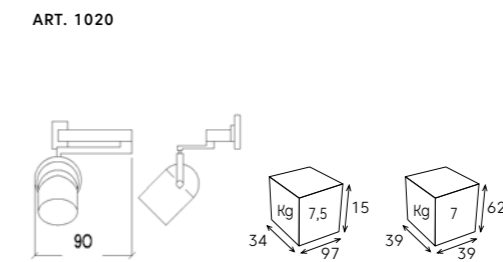
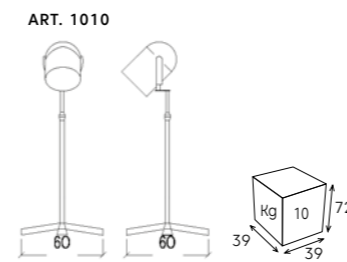

victor - ART. 1610 - muro - ART. 1620



ART. 1610

ART. 1620

ART. 1610 - 1620 - Vaporizzatore con temporizzatore e regolazione dell'intensità del vapore, costruito in nylon, caldaia in acciaio inox, colori di serie: nero o grigio argento metallizzato.
 Hairstreamer with timer and steam setting, built in nylon, inox kettle, standard colour: metal black or silver.
 Casque a vapeur avec temporisateur et réglage de l'intensité du vapeur, construit en nylon, chaudière en acier inox, couleurs de serie: noir ou gris métallisé.

ART. 1610

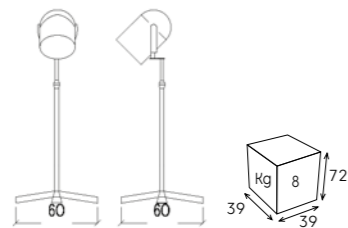

ART. 1620

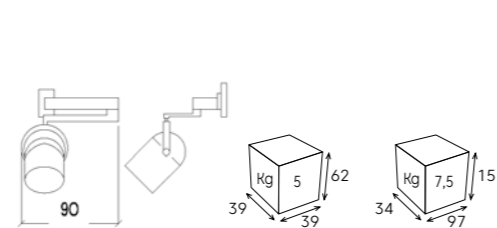

Lucé - ART. 1810 - muro - ART. 1820 - testata - ART. 1800



ART. 1810



ART. 1820



ART. 1800

ART. 1810 - 1820 - 1800 - Lampada ventilata, interno acciaio, esterno termoformato grigio, resistenze circolari al quarzo regolabili singolarmente, temporizzatore 60', potenza 1400 watts 230 volts 50-60 hz, colori di serie: grigio chiaro.
 Airy lamp, inside frame in steel, outside in polyurethane grey, circular quartz resistances adjusting separately, timer 60', power 1400 watts 230 volts 50-60 hz, standard colour light grey.
 Lampe aère, structure intérieure en acier, extérieure en poliurethane gris, résistances circulaires au quartz réglables separement, timer 60', puissance 1400 watts 230 volts 50-60 hz, couleurs de serie: gris claire.

ART. 1810

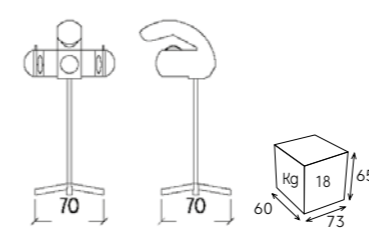

ART. 1820

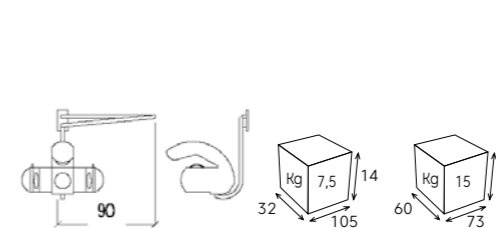

ART. 1800

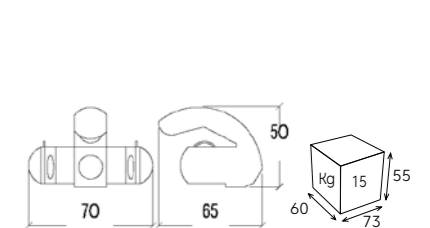

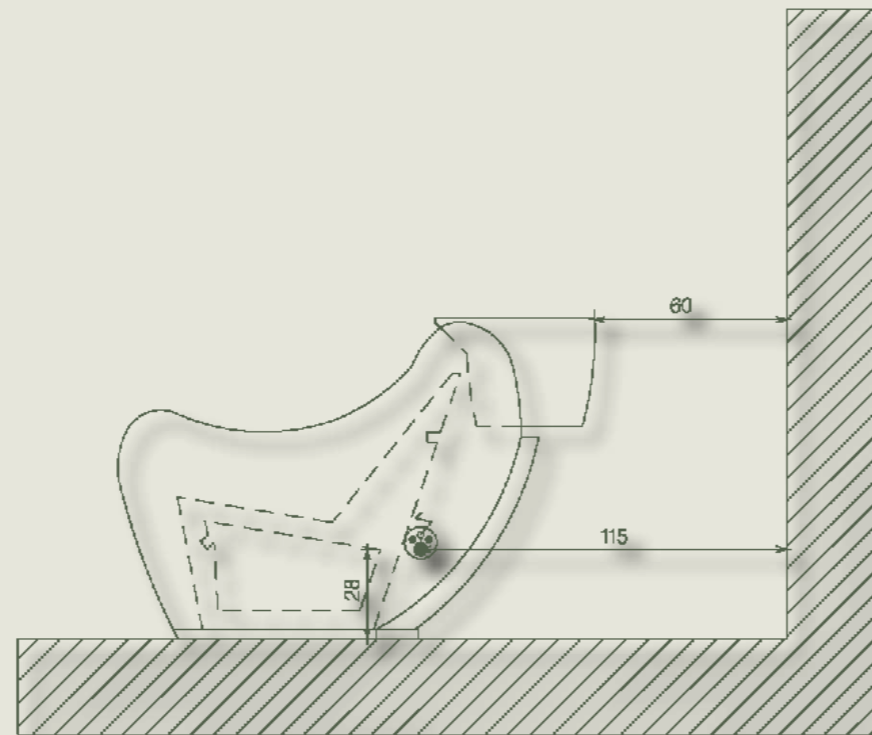
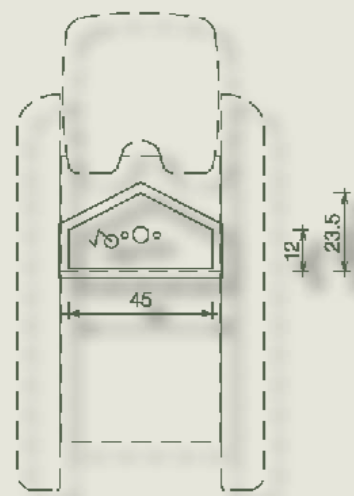
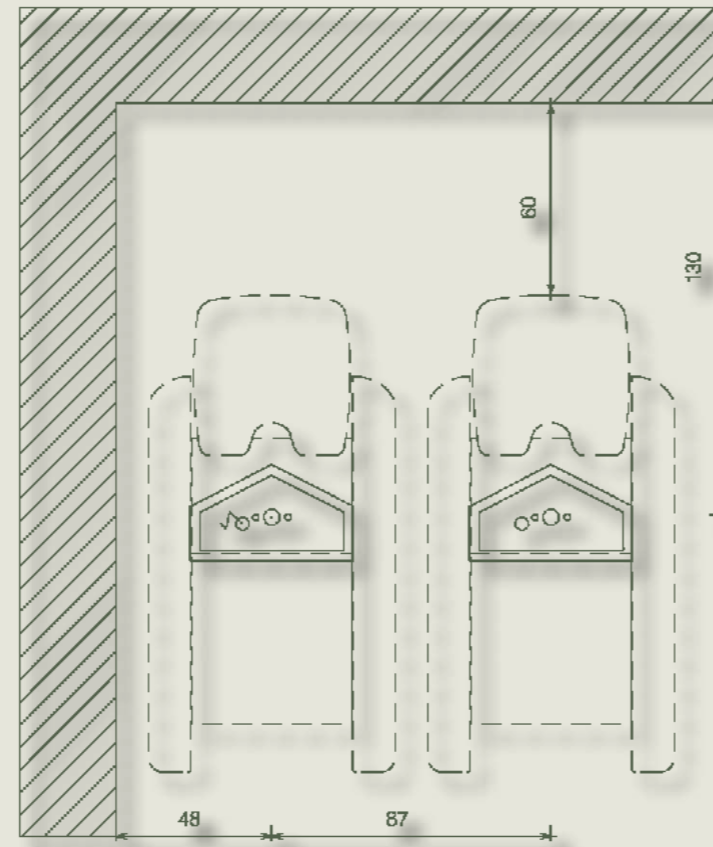
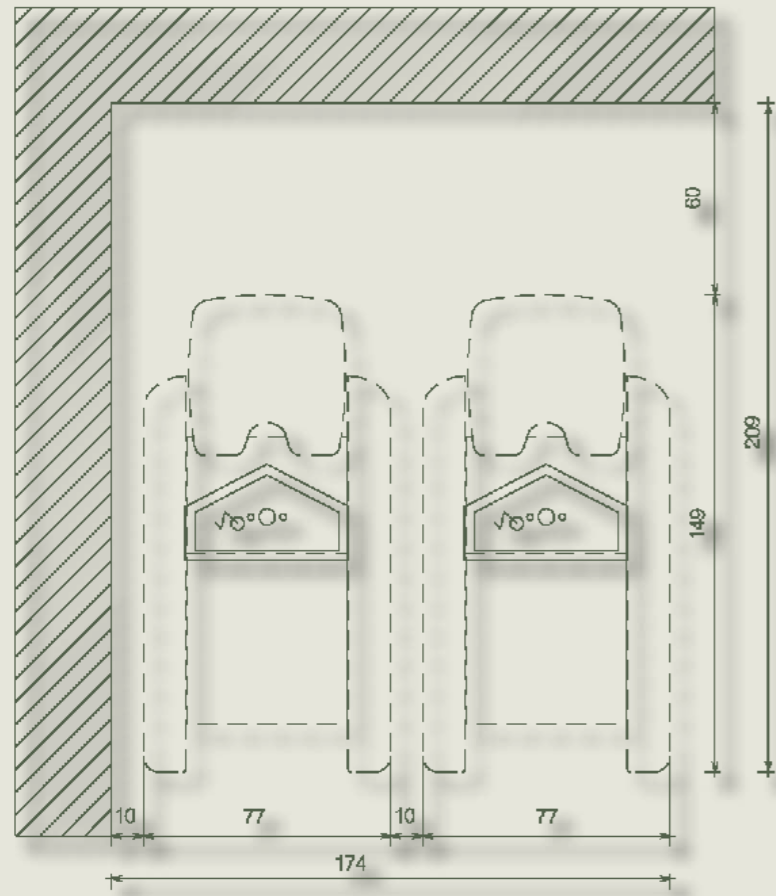

12

schemi idraulici
hydraulic plans
schémas hydrauliques

industrial - ART. 3110 - relax - ART. 3115 - massage - ART. 3120 

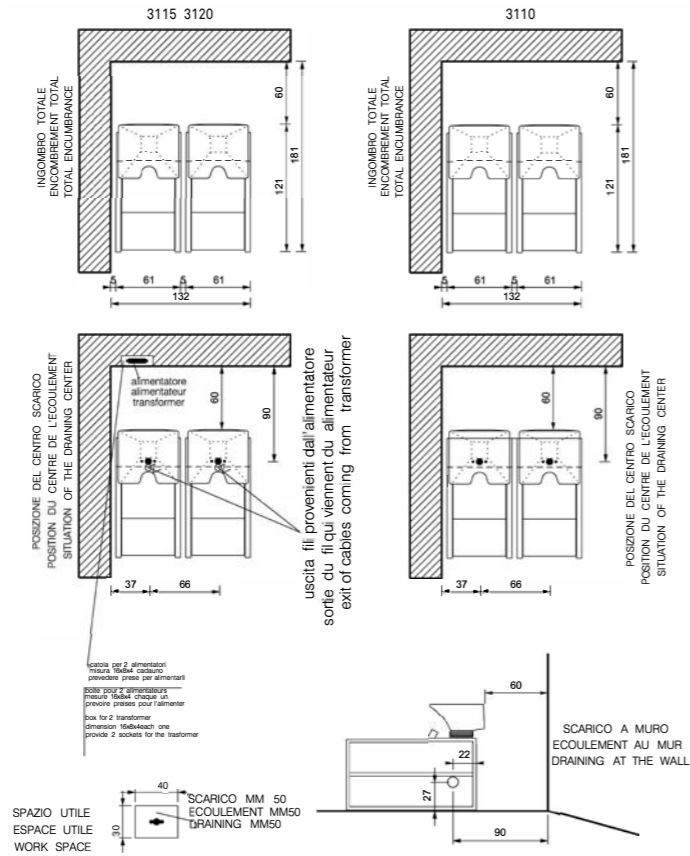

fancy - ART. 3045 - relax - ART. 3050 - massage - ART. 3055 

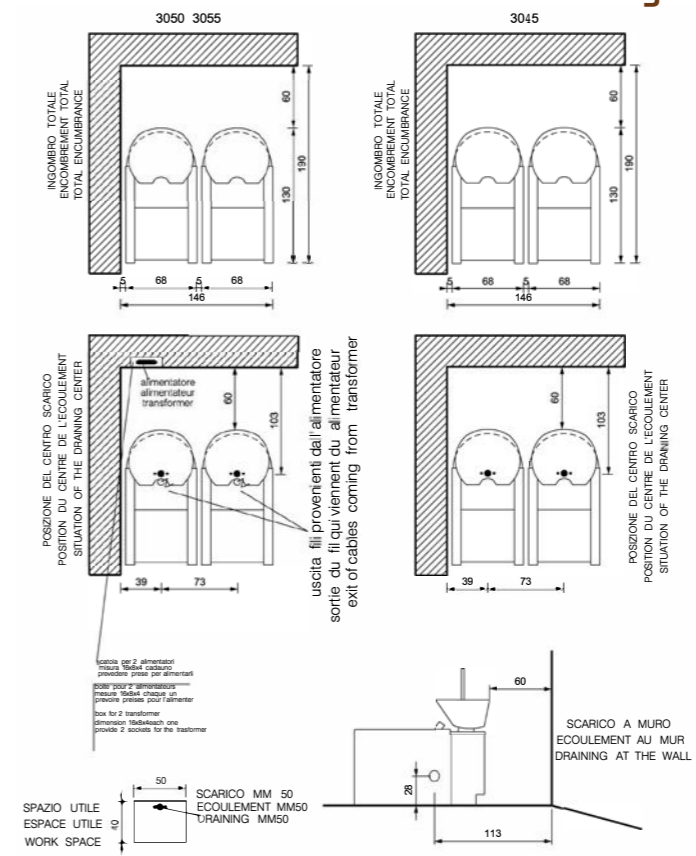

flora beauty basket - ART. 3075 - relax - ART. 3080 - massage - ART. 3085 

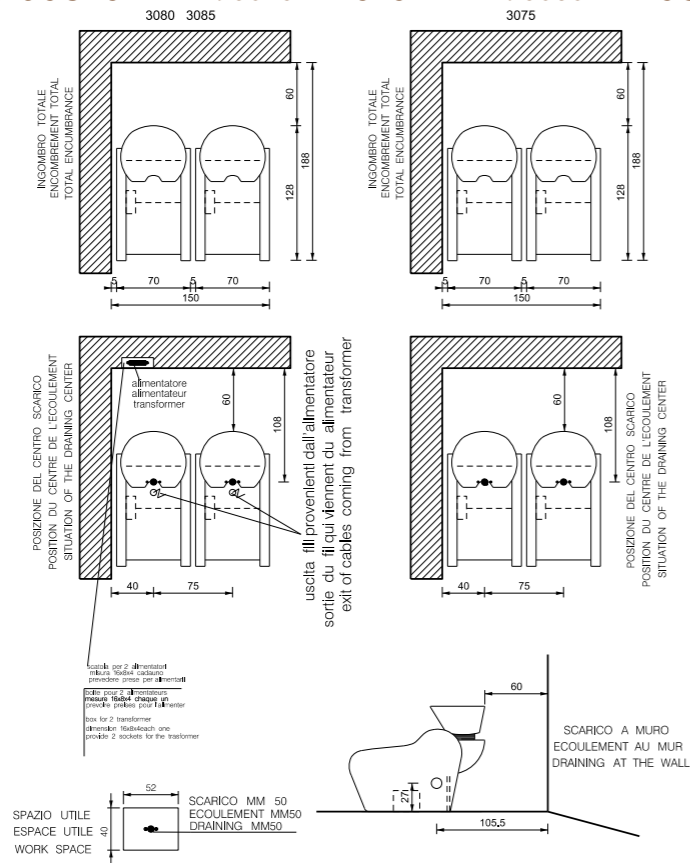

iron - ART. 3038 - relax - ART. 3039 - massage - ART. 3040 

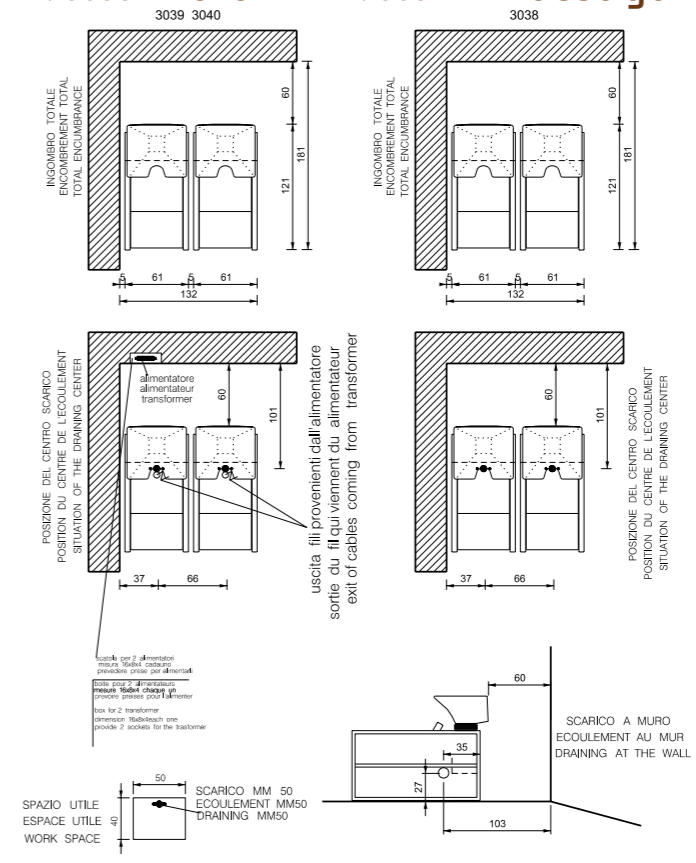

cuive - ART. 9805

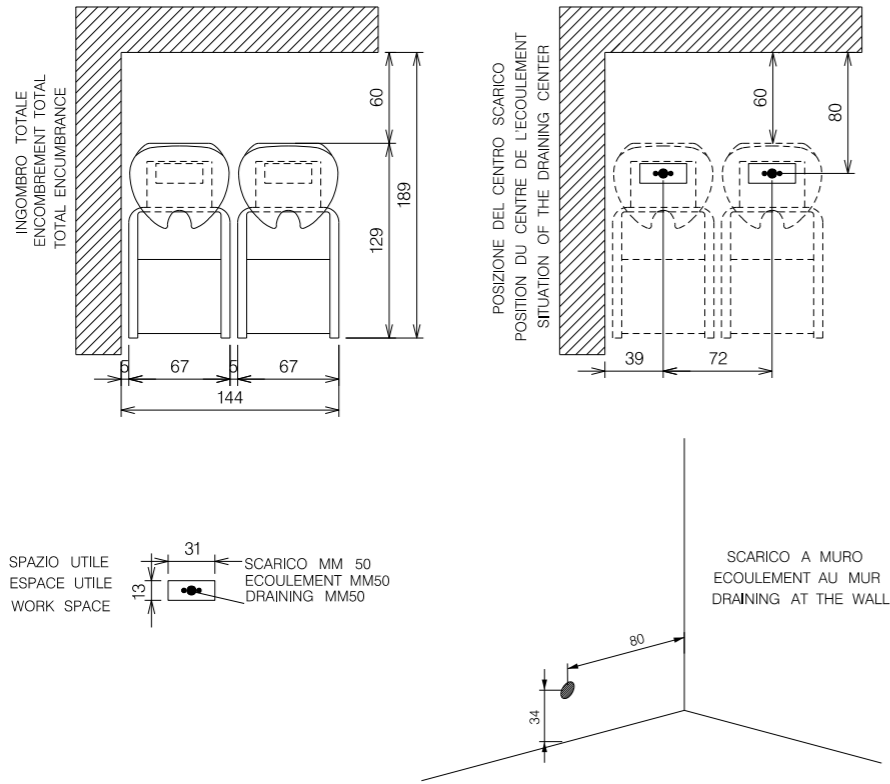

cooper - ART. 3280

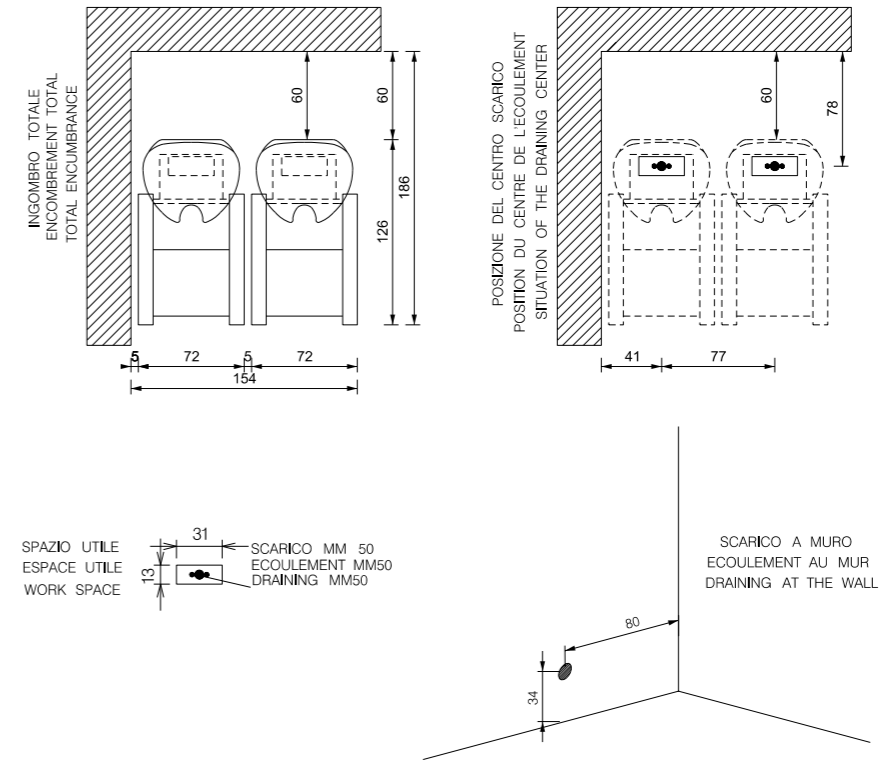

cuive relax - ART. 9806 - massage - ART. 9807

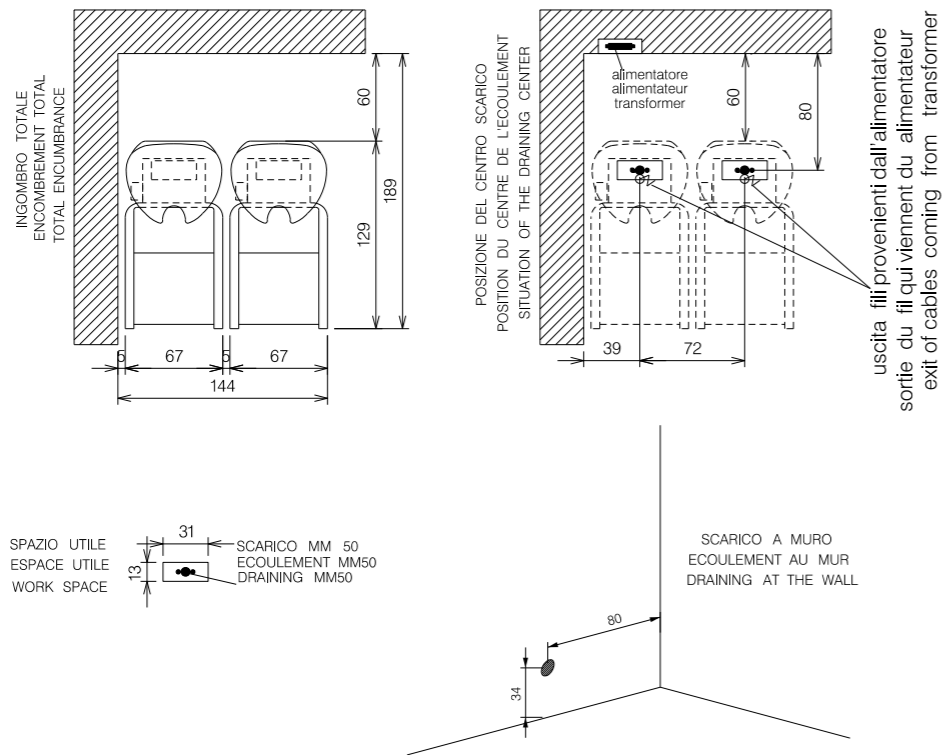

cooper relax - ART. 3285 - massage - ART. 3290

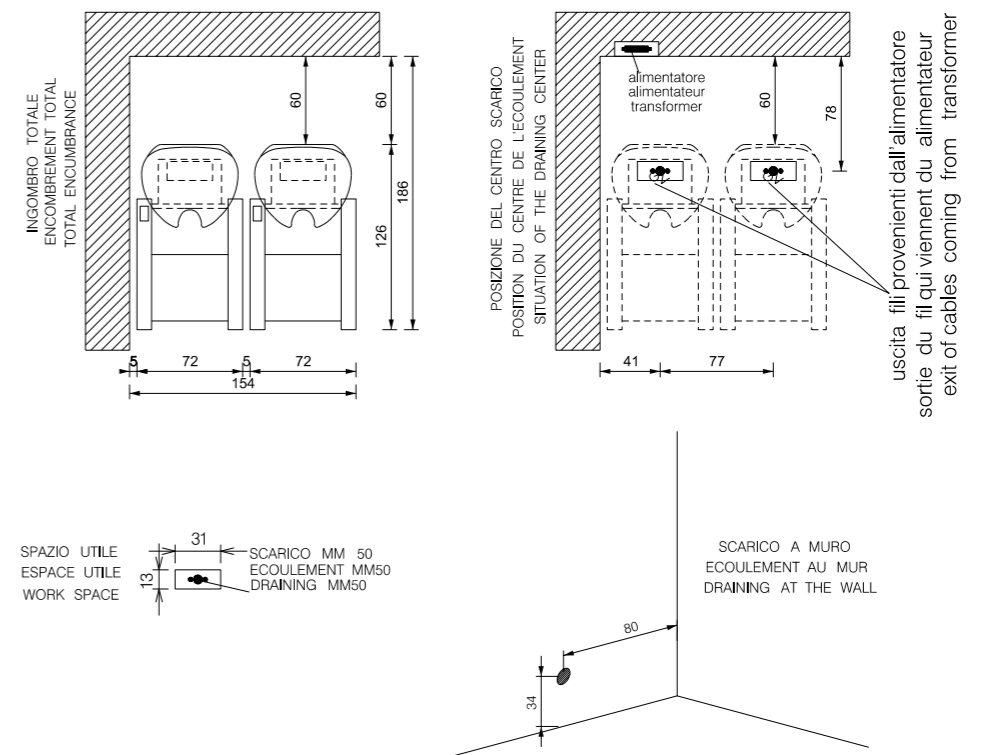

push-up relax - ART. 3350 - massage - ART. 3360 

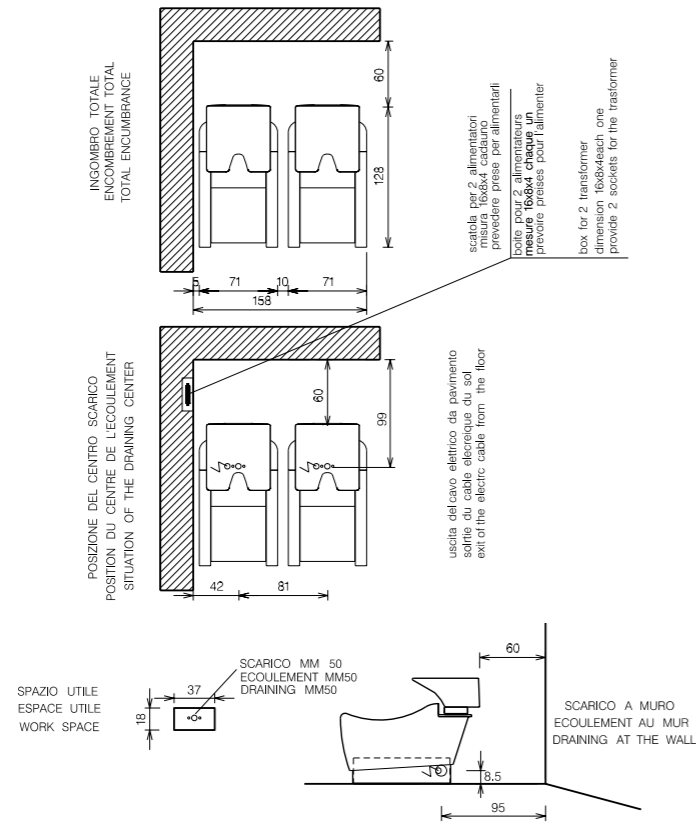

pod - ART. 9001

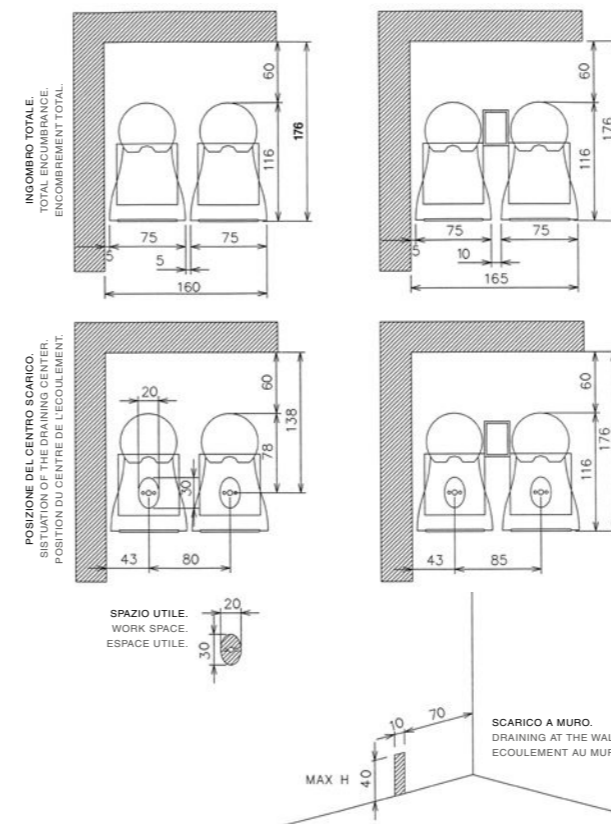

pod relax - ART. 9004 - massage - ART. 9003 

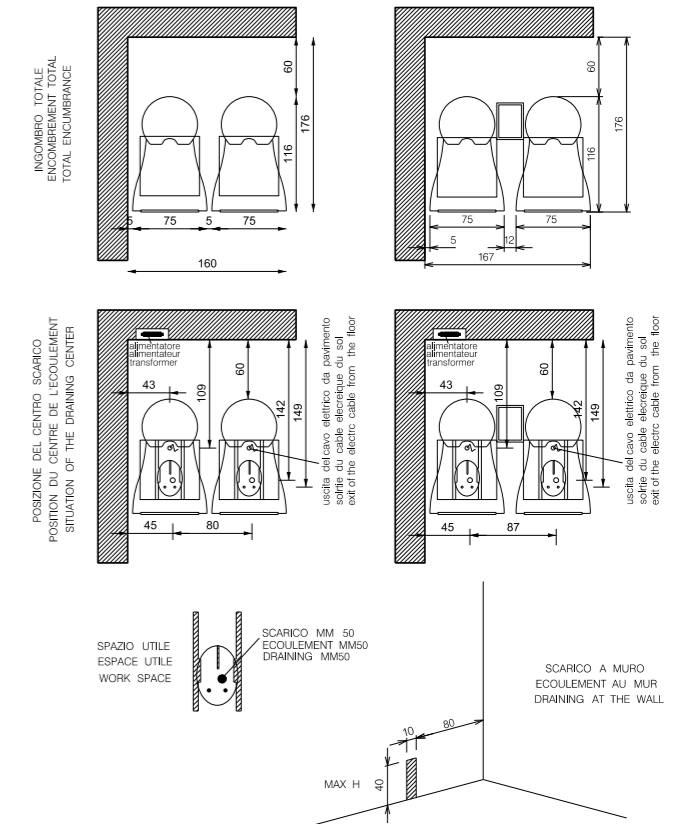

hop - ART. 3335 - relax - ART. 3340 - massage - ART. 3345 

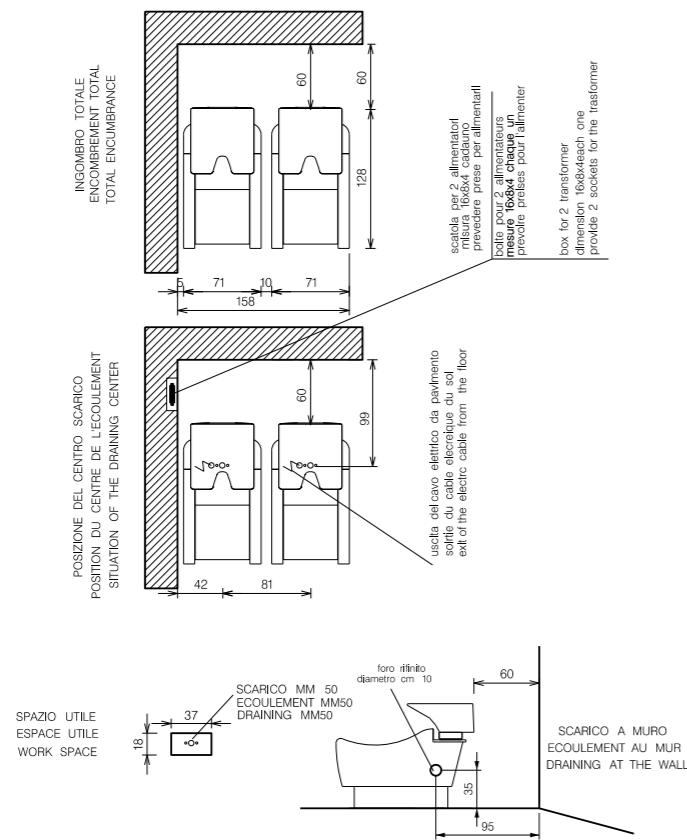

napoleone - ART. 3130 - napoleone III - ART. 3135

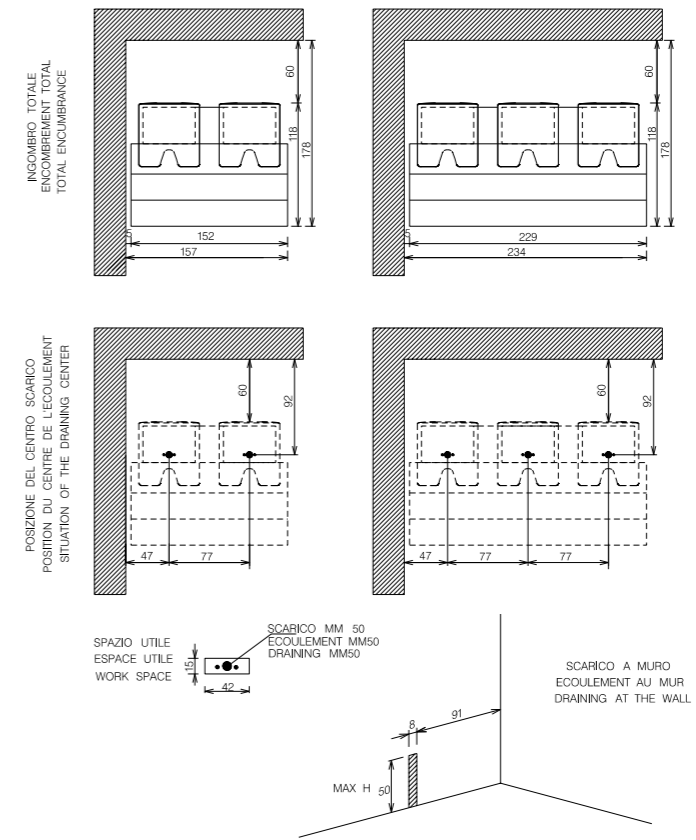

dylan - ART. 3295

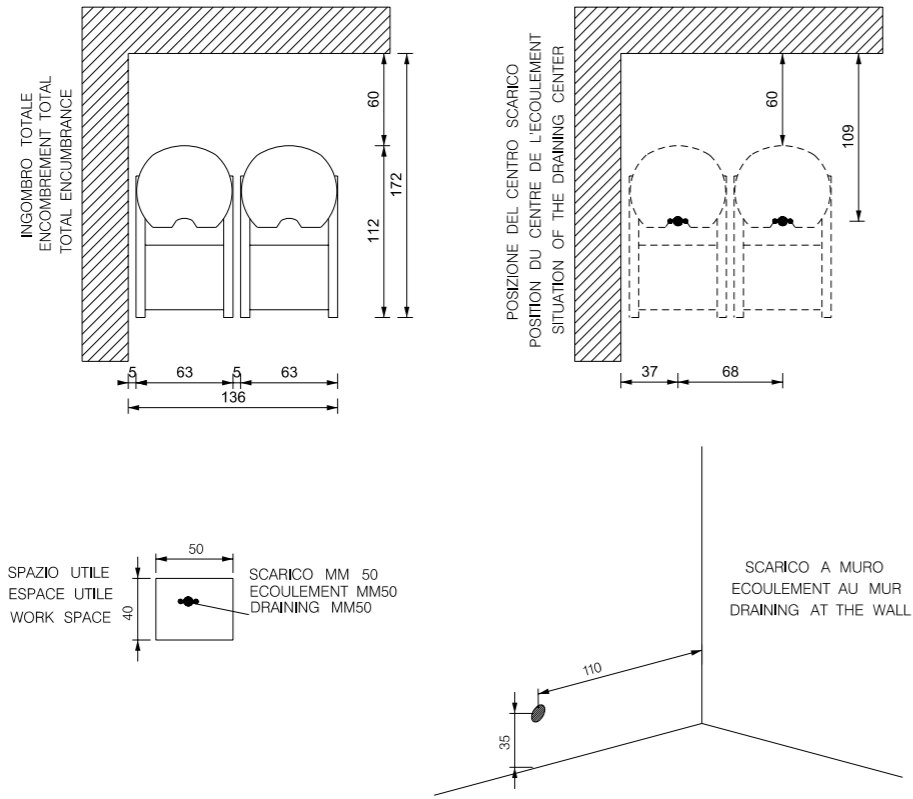

royal wash - ART. 8070

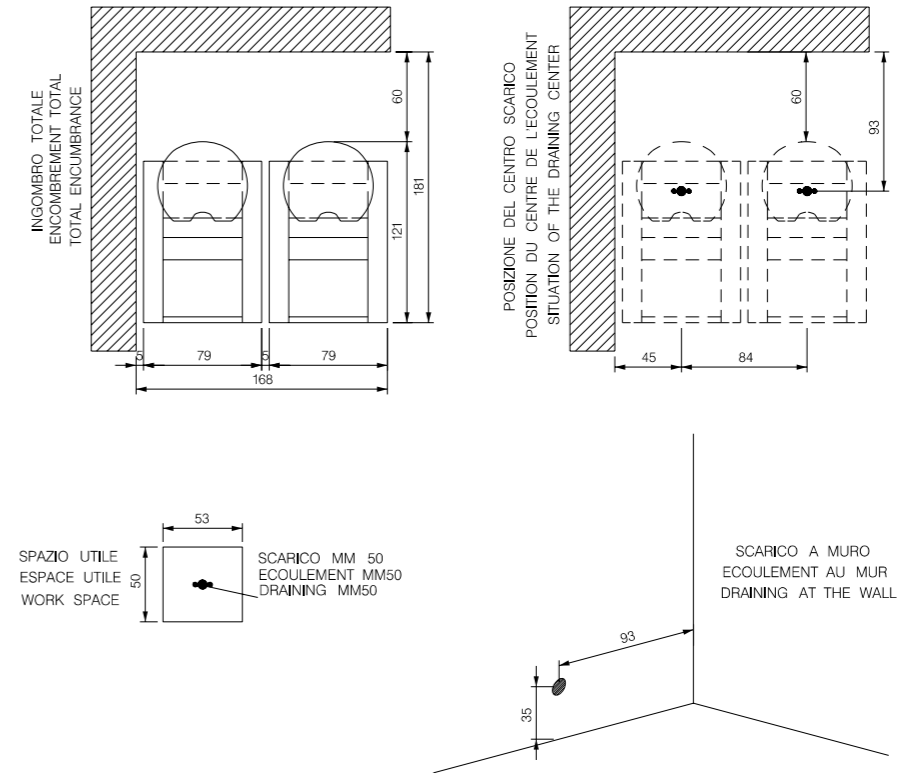

dylan relax - ART. 3300 - massage - ART. 3305

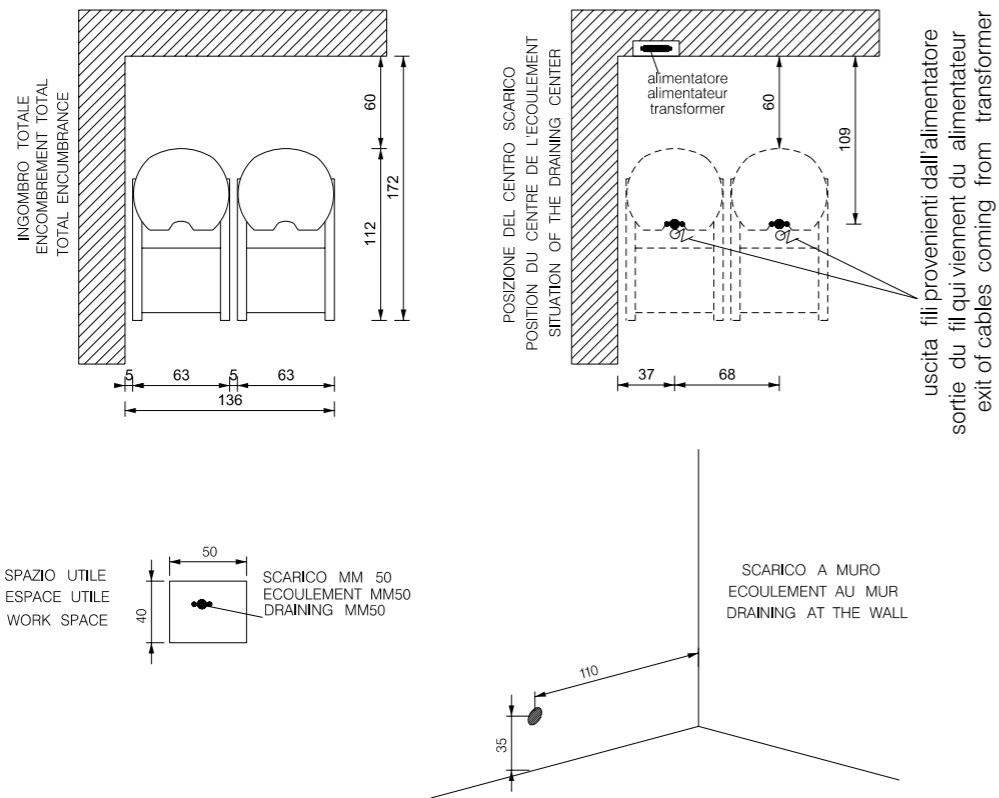

royal wash relax - ART. 8075 - royal wash massage - ART. 8077

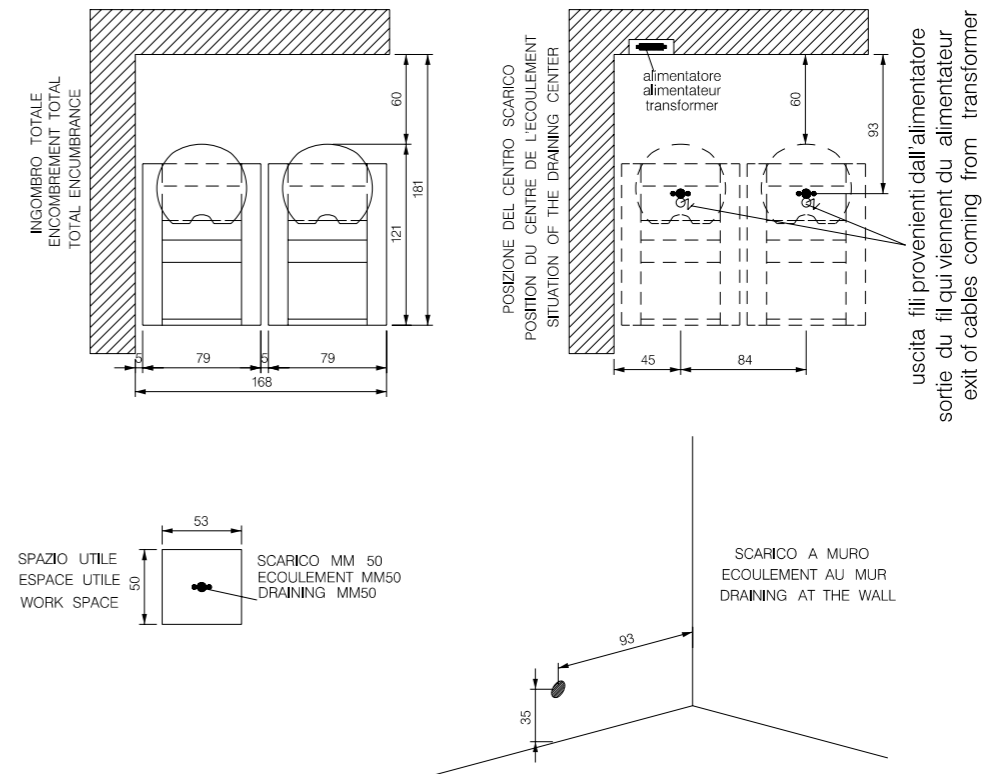

eddie - ART. 8060/16

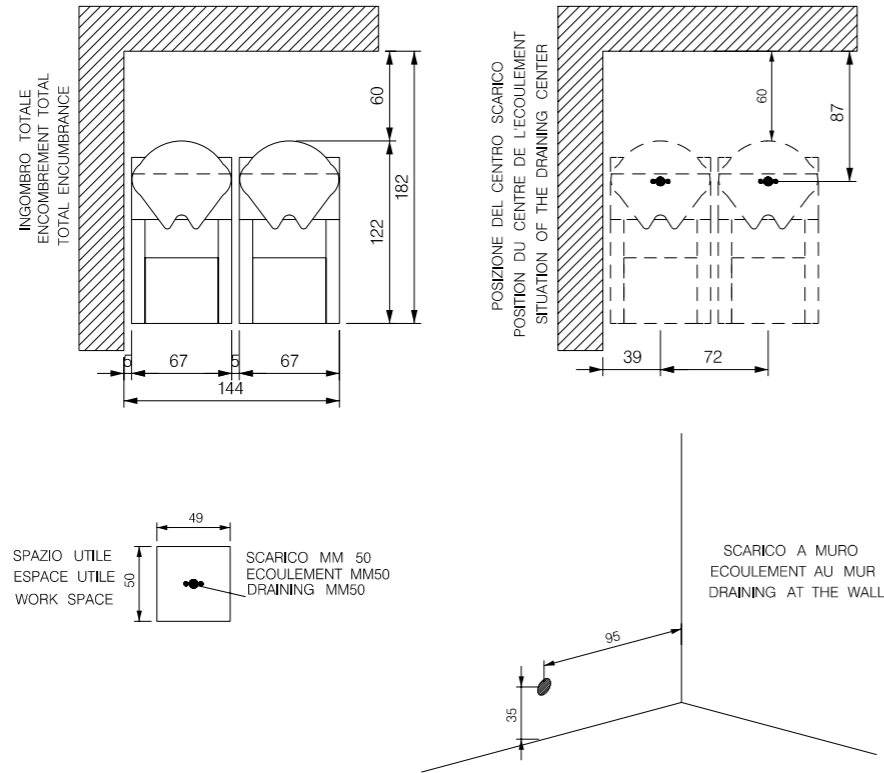

eddie sofá - ART. 8066

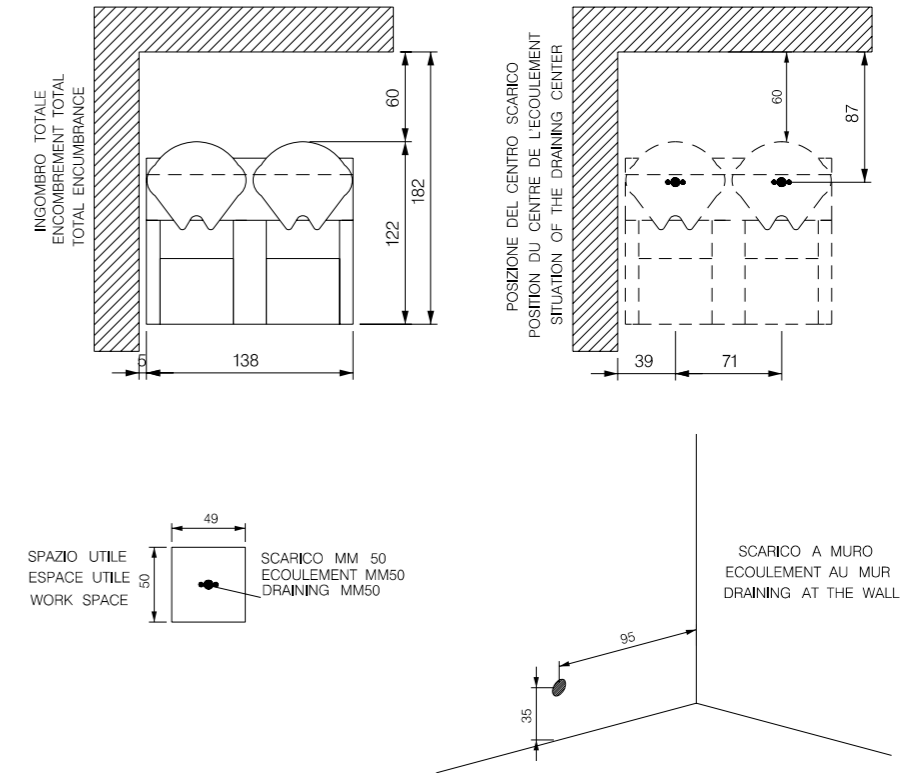

eddie relax - ART. 8065/16 - massage - ART. 8069/16

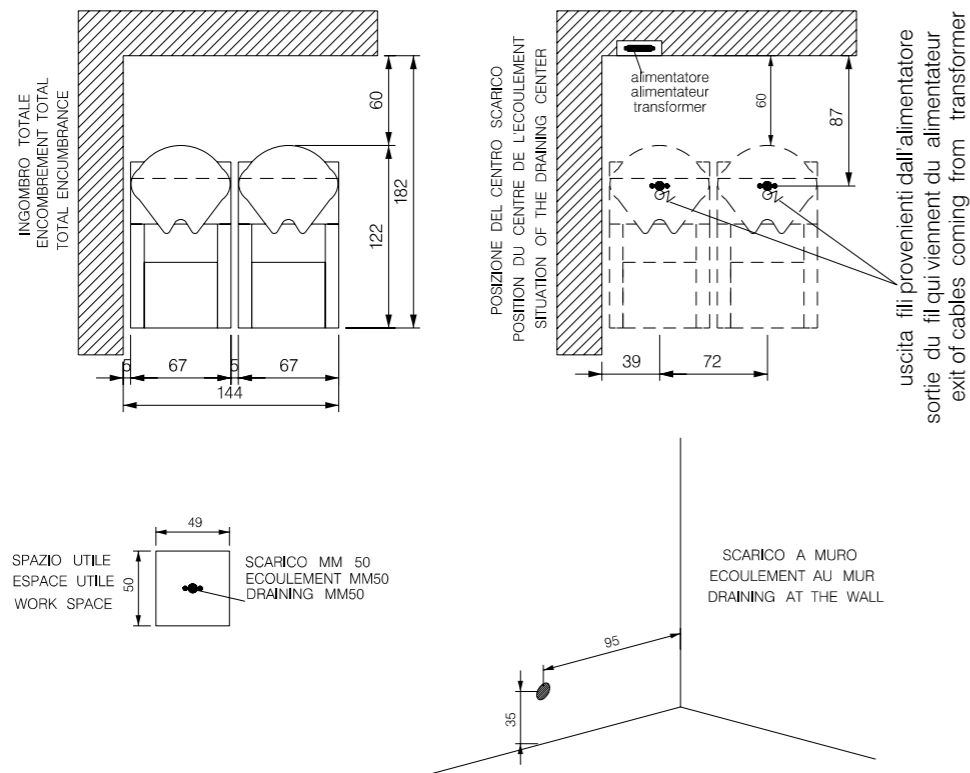

eddie sofá relax - ART. 8067 - eddie sofá massage - ART. 8068

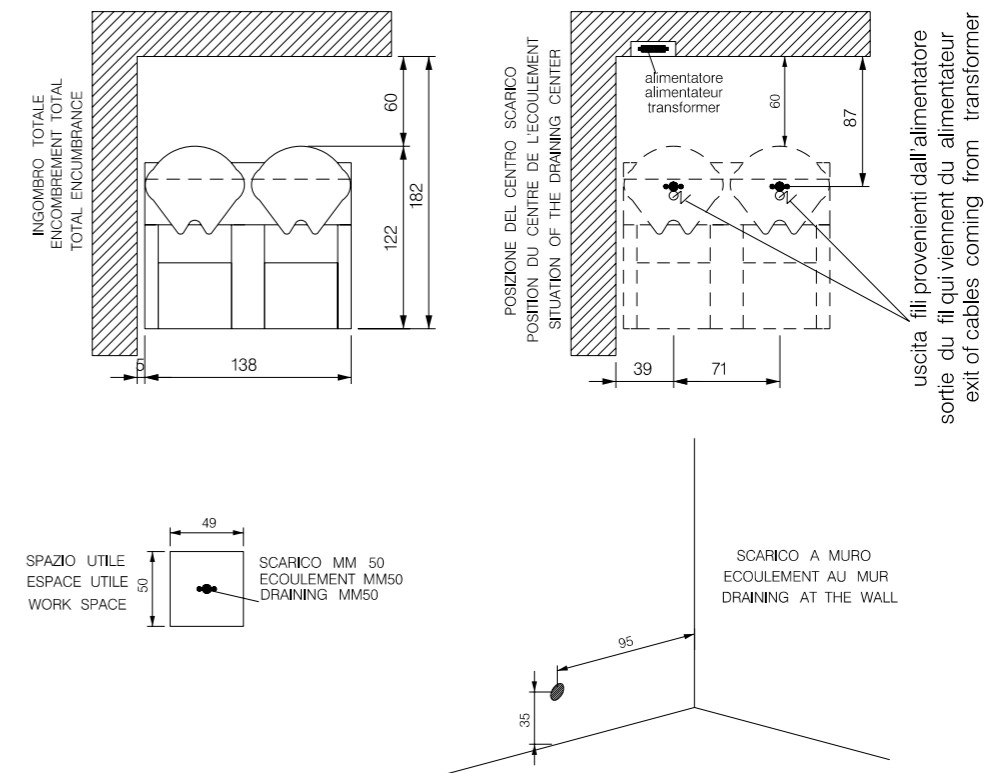



13

colori e materiali
colours and materials
coloris et matériaux

 **VEZZOSI**

tappezzeria - upholstery - tapisserie: normal skai



tappezzeria - upholstery - tapisserie: top skai



tappezzeria - upholstery - tapisserie: special skai

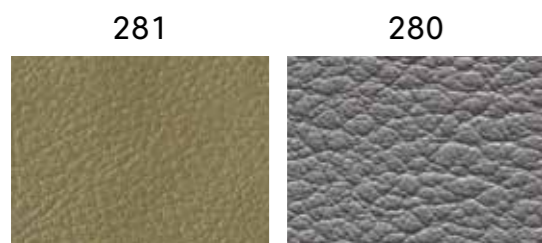

laminati - plastic laminated - stratifiés



nobilitato - pre-laminated - laminé

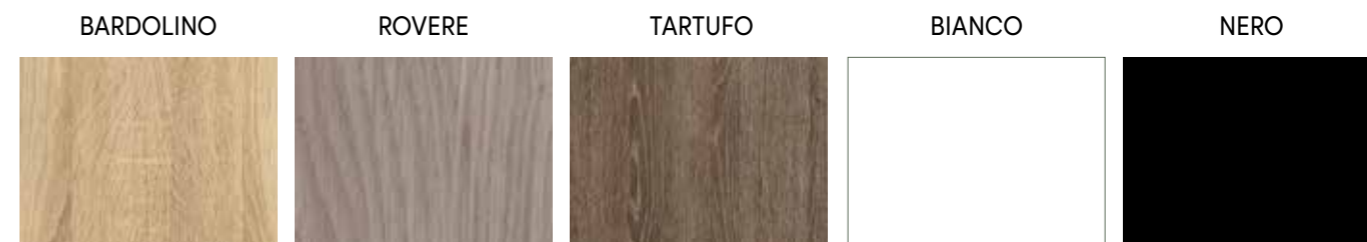

collezione Fancy - Fancy collection - collection Fancy



Gres porcellanato.
Porcelain stoneware.
Grès cérame.



VEZZOSI

Le informazioni contenute nel presente catalogo sono il più possibile esatte, ma non sono da ritenersi vincolanti.

Il colori e gli effetti riportati sul presente catalogo sono indicativi per i limiti consentiti dalla stampa; per questo non possono essere vincolanti e costituire base per eventuali contestazioni.

The information contained in this catalogue is as accurate as possible, but cannot be considered as legally binding.

Colours and aesthetic effects shown on this catalogue should be considered indicative and approximate as a result of printing process limits. Possible variations may occur and can not be at the base of any claim.

Les informations reprises dans ce catalogue sont exactes, mais elles n'engagent aucunement notre Société du point de vue légal.

Les couleurs et les effets présentés dans ce catalogue sont indicatifs dans la mesure permise par la presse, ce qui explique pourquoi ils ne peuvent pas être obligatoire et constituer la base d'un éventuel désaccord.

Credit:

coordinamento marketing:

 **VEZZOSI**

progetto grafico:

EUREKA

finito di stampare:

APRILE 2022

www.vezzosisrl.com

VEZZOSI SRL

Via Martiri della Romania, 9
42020 Borzano di Albinea(RE) Italy

Tel: +39 0522 591721

Fax: +39 0522 591298

Whatsapp: +39 3703260829

info@vezzosiarredamenti.com

