

נמל

 VEZZOSI



CU
29

Il rame

Bellezza, luce,
calore, design,
eleganza,
e stile.

Copper

Beauty, light,
warmth, design,
elegance,
and style.



Doppiospazio ⁵

4

-- **doppiospazio** è uno studio poliedrico che si occupa di architettura, design, grafica e comunicazione.

Il team è in grado di garantire unità concettuale e progettuale in tutte le fasi di analisi, ideazione e realizzazione dell'identità comunicativa ed architettonica di ogni cliente; una creatività globale con una forte sensibilità etica ed ecologica.

La **collezione CU29** è nata dalla ricerca di forme che potessero trasmettere una sensazione di leggerezza e comodità. Segue linee morbide e sinuose tracciate da un tondino color rame, metallo protagonista della collezione, che alleggerisce ed esalta la struttura dei prodotti.

Il contrasto con i dettagli in ceramica e il grigio grafite completa con eleganza l'aspetto estetico.

Ogni elemento è pensato per essere modulare e versatile permettendo alla collezione di essere implementata secondo le esigenze di ogni salone.

-- **doppiospazio** is a multifaceted studio that deals with architecture, design, graphics and communication.

The team is able to guarantee conceptual and design unity in all phases of analysis, conception and creation of the communicative and architectural identity of each client; a global creativity with a strong ethical and ecological sensitivity.

The **CU29 collection** was born from the search for shapes that could convey a feeling of lightness and comfort.

It follows soft and sinuous lines traced by a copper-colored rod, the protagonist metal of the collection, which lightens and enhances the structure of the products.

The contrast with the ceramic details and the graphite gray elegantly completes the aesthetic appearance.

Each element is designed to be modular and versatile allowing the collection to be implemented according to the needs of each salon.



6

7

La bellezza ha il potere
di trasformare anche
i momenti più ordinari
in ricordi indimenticabili.

Beauty has the power to transform even
the most ordinary moments
into unforgettable memories.

 **VEZZOSI**

2021





10



2020

CHAISE LONGUE MASSAGE
+ FLAMINGO TOTEM

11



CHAISE LONGUE



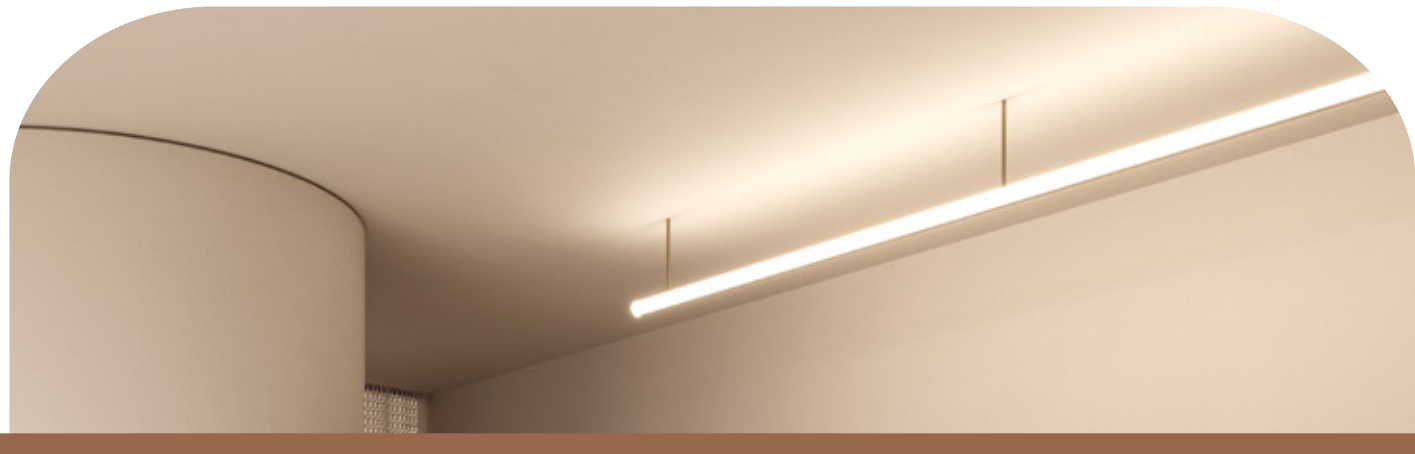

2020

WASH



12

13



CHAIR + WALL



La luce danza e
svela mondi riflessi
di pura magia.

Light dances and
reveals reflected worlds
of pure magic.



WALL

200
200



Il calore avvolge il cuore,
trasformando
i momenti più semplici
in abbracci indimenticabili.

Warmth envelops the heart,
turning the simplest moments
into unforgettable embraces.

 **VEZZOSI**



2020



CHAIR





WAITING

2020

 **VEZZOSI**

Il design è ovunque,
basta avere occhi
per vederlo
e cuore
per apprezzarlo.

Design is everywhere,
you just need to have
eyes to see it and a heart
to appreciate it.

SOFA



DESK + EXPO

2020





26

DESK

2020

27

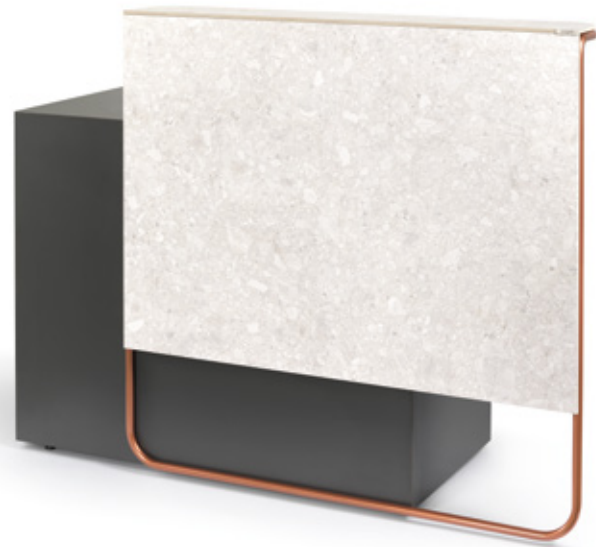



L'eleganza è
un rifugio sereno
dove ogni dettaglio
racconta la storia
di un gusto raffinato.

Elegance is a serene refuge
where every detail tells
the story of refined taste.



2020

EXPO



31

FURNISHING

2020



30





VEZZOSI

VEZZOSI

Lo stile è
 un viaggio personale
 che intreccia sogni
 e passioni, creando
 un'impronta unica e
 indimenticabile.

Style is a personal journey
 that intertwines dreams and passions,
 creating a unique and
 unforgettable imprint.



ART. 3225 CU29 WASH

Colonna e braccioli in metallo verniciato rame, lavello bianco o nero.
Column and armrest in painted copper metal, tilting basin white or black.
Colonne et accoudoirs en métal verni cuivre, cuvette basculante noir ou blanc.
Column y brazos en metal pintado cobre, pica basculante blanca o negra.

ART. 3226 CU29 WASH RELAX

Poggiagambe regolabile elettricamente.
Electronically adjustable legrest.
Repose jambes réglable électroniquement.
Apoja piernas eléctrico.

ART. 3227 CU29 WASH MASSAGE

Massaggio totale ad aria.
Full air massage.
Massage total à air.
Masaje total de aire.

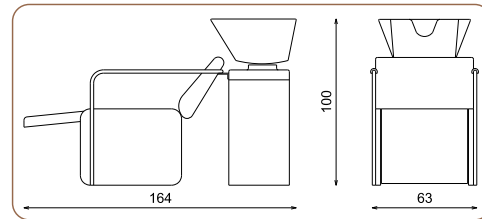

CU
29



ART. 7276 CU29 EROGATORE

Erogatore esterno.
External dispenser.
Distributeur extérieur.
Dispensador externo.

CU
29

schemi idraulici - hydraulic plans - schemas hydrauliques CU29 3226 - CU29 3227

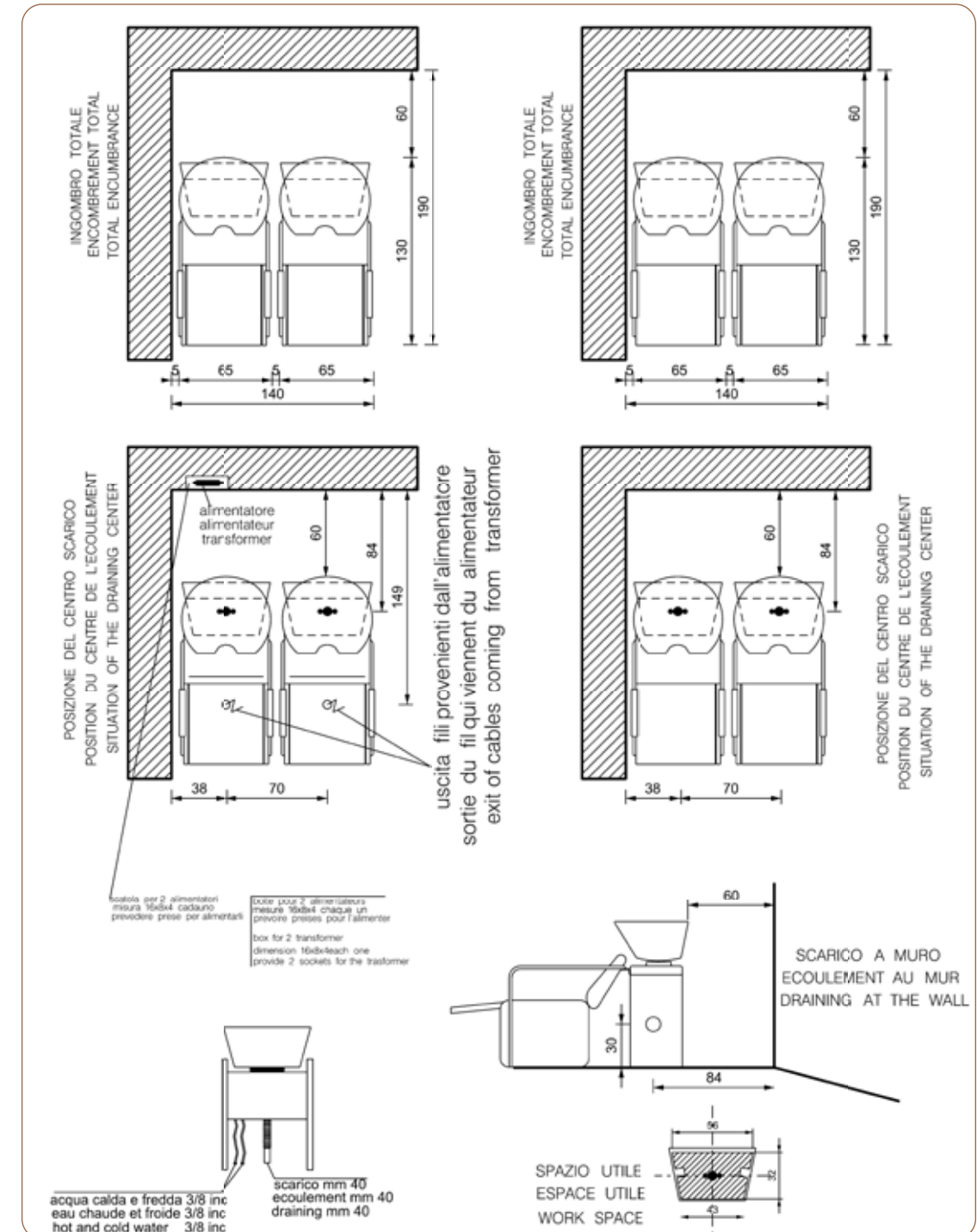

ART. 3228 CU29 CHAISE LONGUE

Colonna e braccioli in metallo verniciato rame, lavello bianco o nero.
Column and armrest in painted copper metal, tilting basin white or black.
Colonne et accoudoirs en métal verni cuivre, cuvette basculante noir ou blanc.
Column y brazos en metal pintado cobre, pica basculante blanca o negra.

ART. 3229 CU29 CHAISE LONGUE MASSAGE

Massaggio totale ad aria.
Full air massage.
Massage total à air.
Masaje total de aire.

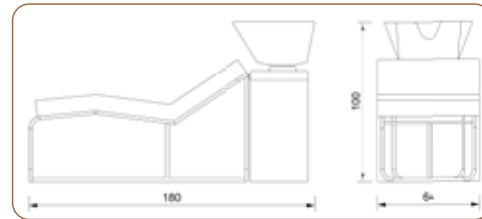

ART. 3229 CU29 CHAISE LONGUE MASSAGE + FLAMINGO TOTEM

ART. 0001 Doccetta e miscelatore integrati.
Handshower and mixer tap integrated.
Mitigeur et douchette intégrés.
Ducha de mano y mezclador integrados.

ART. 0002 Doccetta e miscelatore integrati, sistema massaggio shirodara, cassa bluetooth.
Handshower and mixer tap integrated, shirodara bowl, bluetooth speaker.
Mitigeur et douchette intégrés, shirodara bol, hautparleur bluetooth.
Ducha de mano y mezclador integrados, shirodara bol, bluetooth speaker.

ART. 0003 Doccetta e miscelatore integrati, sistema massaggio shirodara, cassa bluetooth. OZONE.
Handshower and mixer tap integrated, shirodara bowl, bluetooth speaker. OZONE.
Mitigeur et douchette intégrés, shirodara bol, hautparleur bluetooth. OZONE.
Ducha de mano y mezclador integrados, shirodara bol, bluetooth speaker. OZONE.





ART. 1304 CU29 CHAIR

Braccioli e base in metallo verniciato rame.
Armrests and base in painted copper metal.
Accoudoirs et base en metal verni cuivre.
Brazos y base en metal pintado cobre.

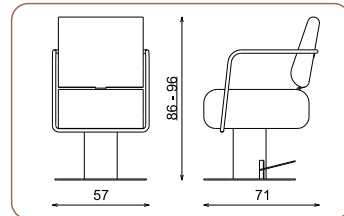

CU29



ART. 4031 CU29 WALL

Struttura in metallo verniciato rame, illuminazione, poggiatesta in ceramica.
Frame in painted copper metal, back lighting, footrest in ceramic.
Structure en metal verni cuivre, éclairage, repose pieds en ceramique.
Estructura en metal pintado cobre, reposa pies en ceramica.

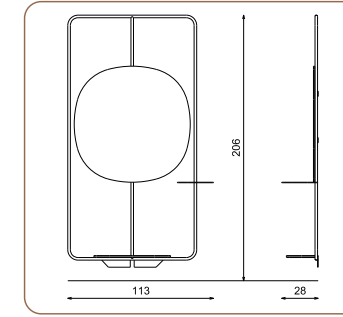

CU29



ART. 2270 CU29 WAITING

Braccioli in metallo verniciato rame.
Armrests in painted copper metal.
Accoudoirs en metal verni cuivre.
Brazos en metal pintado cobre.

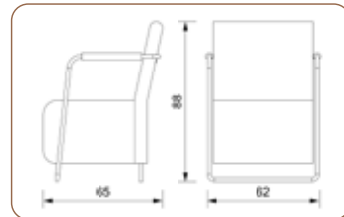

ART. 9379 CU29 FURNISHING

Struttura in laminato, telaio in metallo verniciato rame frontale in ceramica.
Frame in laminated and painted copper metal, frontal in ceramic.
Structure en stratifié et metal verni cuivre, frontal en ceramique.
Estructura en laminado y metal pintado cobre, frontal de ceramica.

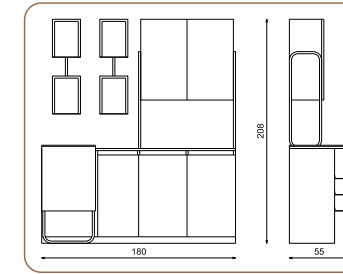

36

37



ART. 2271 CU29 SOFÀ

Braccioli in metallo verniciato rame.
Armrests in painted copper metal.
Accoudoirs en metal verni cuivre.
Brazos en metal pintado cobre.

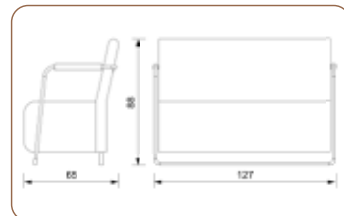

ART. 511 CU29 EXPO

Struttura in metallo verniciato rame e specchio.
Frame in painted copper metal and mirror.
Structure en metal verni cuivre et miroir.
Estructura de metal pintado cobre y espejo.



ART. 6828 CU29 DESK

Struttura in laminato, telaio in metallo verniciato rame frontale in ceramica.
Frame in laminated and painted copper metal, frontal in ceramic.
Structure en stratifié et metal verni cuivre, frontal en ceramique.
Estructura en laminado y metal pintado cobre, frontal de ceramica.

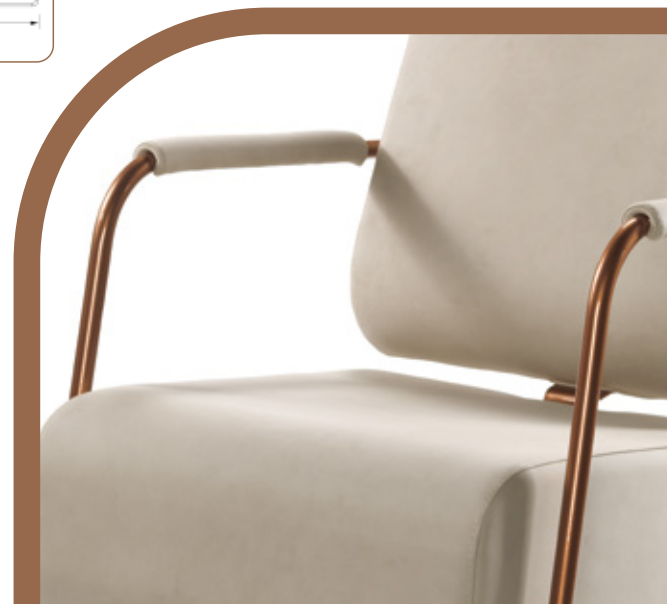
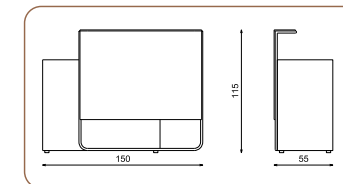

CU29
è l'arte
di dare forma
ai sogni

CU29
is the art
of shaping dreams



VEZZOSI

Via Martiri della Romania, 9
42010 Borzano - Albinea (RE) Italy
Tel +39 0522 591721 - Fax +39 0522 591298
www.vezzosisrl.com
info@vezzosiarredamenti.com